

Algorithmen II

Peter Sanders, Timo Bingmann

Übungen:

Tobias Heuer, Sebastian Lamm

Institut für Theoretische Informatik

Web:

http://algo2.itl.kit.edu/AlgorithmenII_WS19.php

5 Maximum Flows and Matchings

[mit Kurt Mehlhorn, Rob van Stee]

Folien auf Englisch

Literatur:

[Mehlhorn / Näher, The LEDA Platform of Combinatorial and Geometric Computing, Cambridge University Press, 1999]

http://www.mpi-inf.mpg.de/~mehlhorn/ftp/LEDABook/Graph_alg.ps

[Ahuja, Magnanti, Orlin, Network Flows, Prentice Hall, 1993]

Definitions: Network

- Network = directed weighted graph with
source node s and sink node t
- s has no incoming edges, t has no outgoing edges
- Weight c_e of an edge e = capacity of e (nonnegative!)

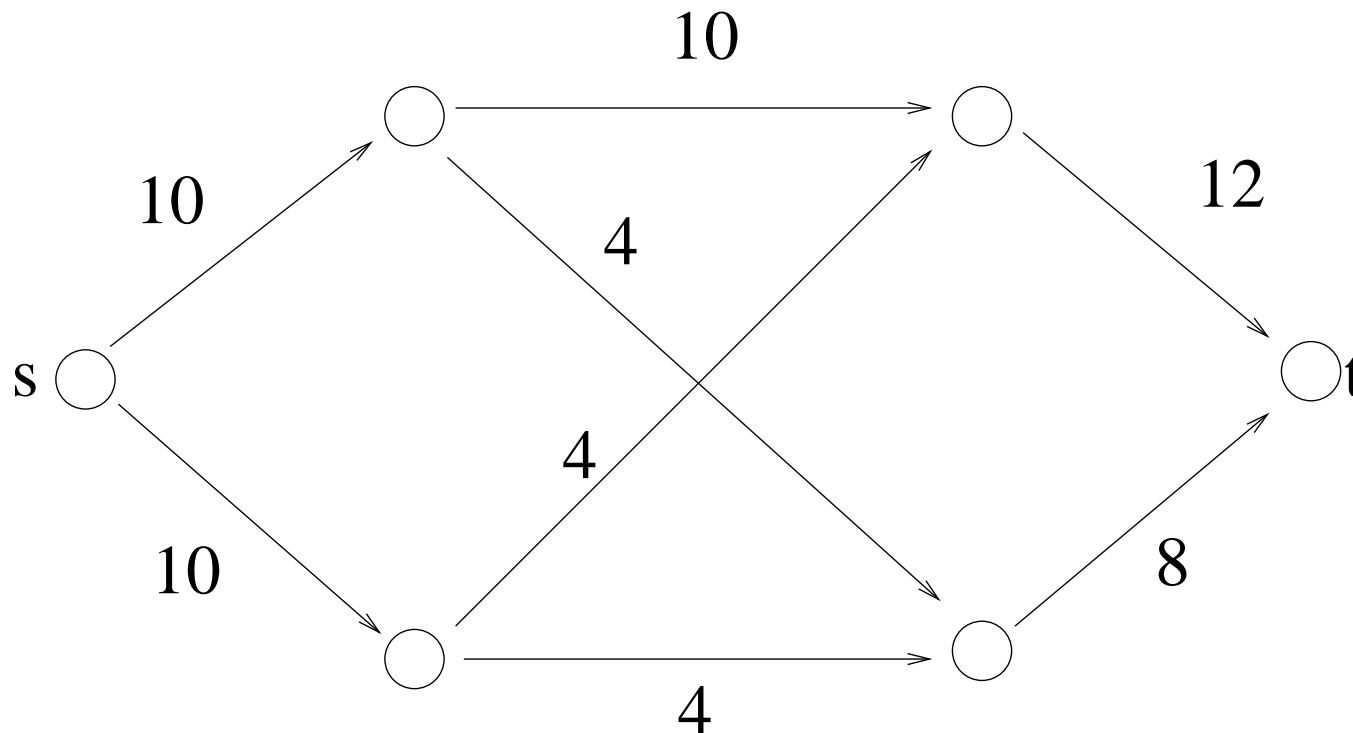

Definitions: Flows

- Flow = function f_e on the edges, $0 \leq f_e \leq c_e \forall e$
 $\forall v \in V \setminus \{s, t\}$: total incoming flow = total outgoing flow
- Value of a flow $\mathbf{val}(f) =$ total outgoing flow from $s =$
total flow going into t
- Goal: find a flow with maximum value

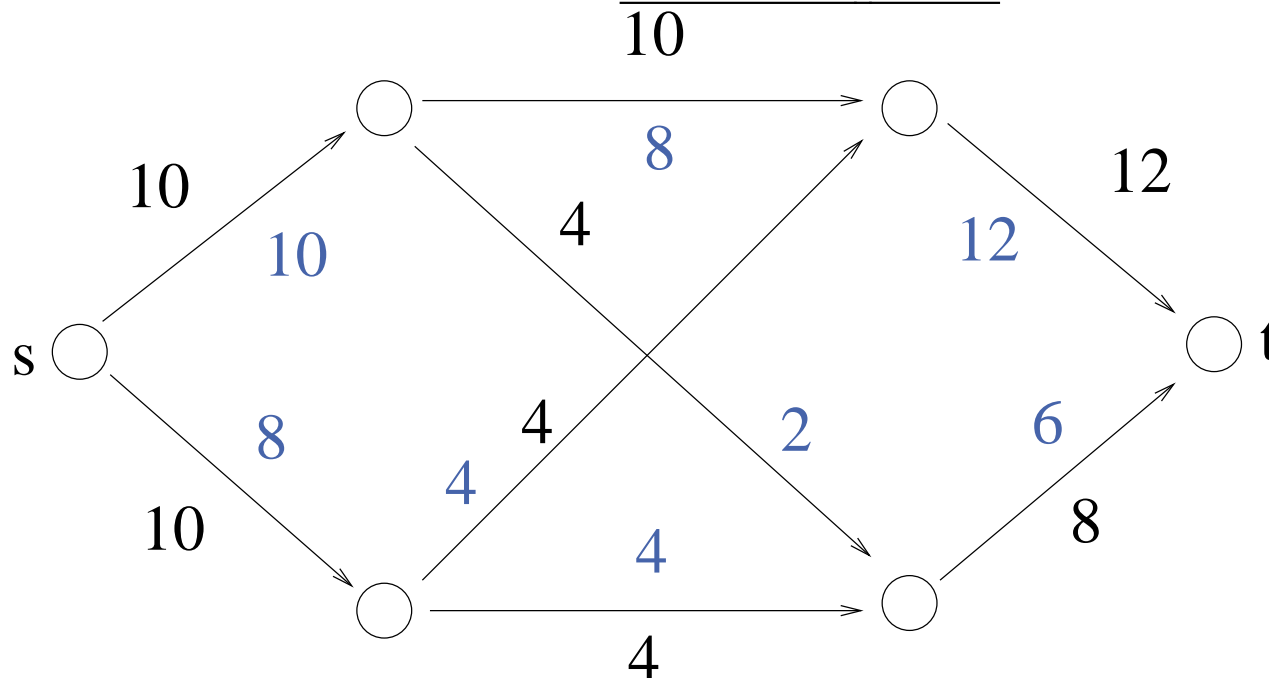

Definitions: (Minimum) s - t Cuts

An s - t cut is partition of V into S and T with $s \in S$ and $t \in T$.

The **capacity** of this cut is:

$$\sum \{c_{(u,v)} : u \in S, v \in T\}$$

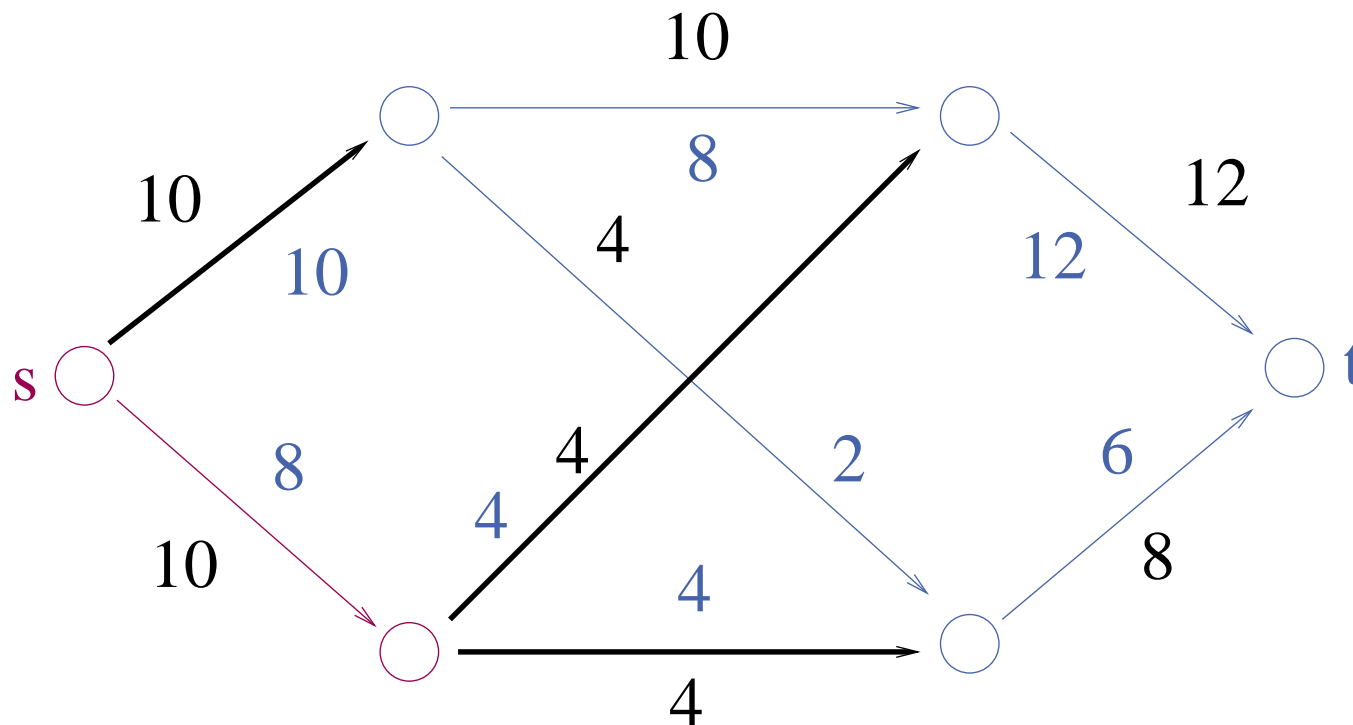

Duality Between Flows and Cuts

Theorem:[Elias/Feinstein/Shannon, Ford/Fulkerson 1956]

Value of an s - t max-flow = minimum capacity of an s - t cut.

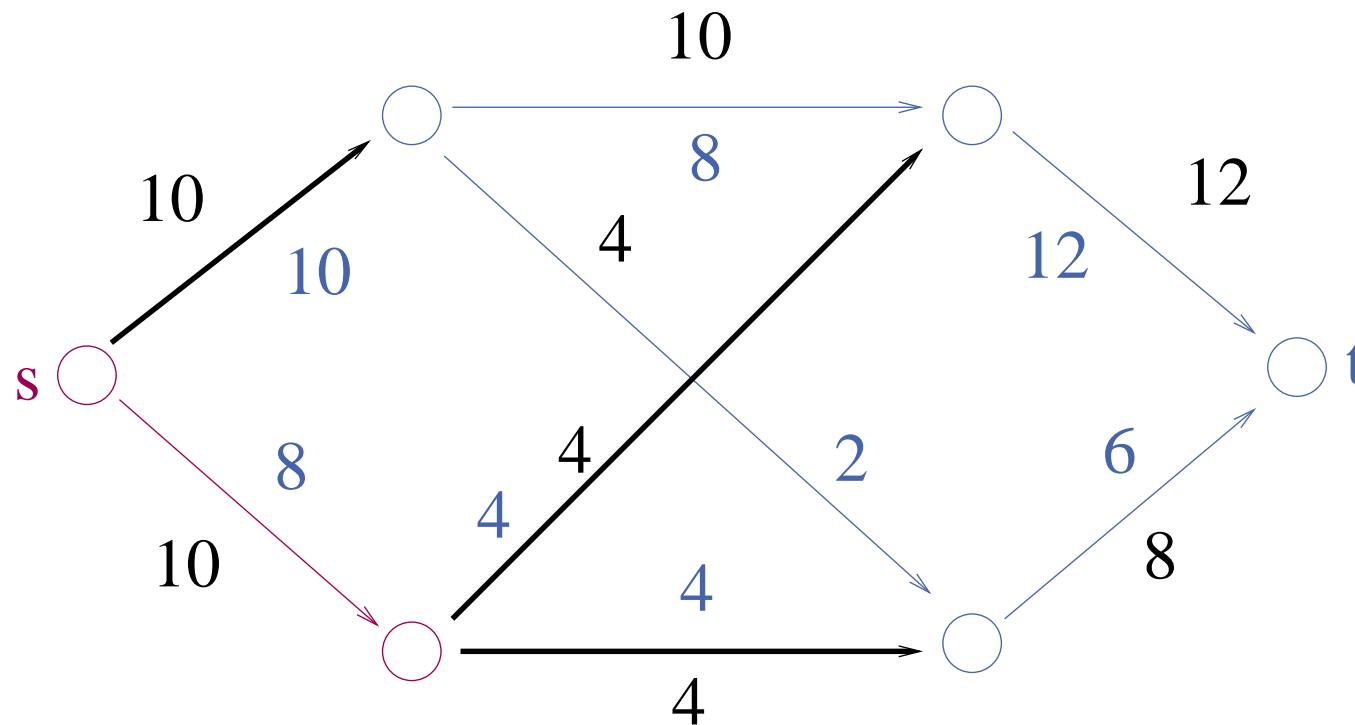

Proof: later

Applications

- Oil pipes
- Traffic flows on highways
- Image Processing** <http://vision.csd.uwo.ca/maxflow-data>
 - segmentation
 - stereo processing
 - multiview reconstruction
 - surface fitting
- disk/machine/tanker **scheduling**
- matrix **rounding**
- ...

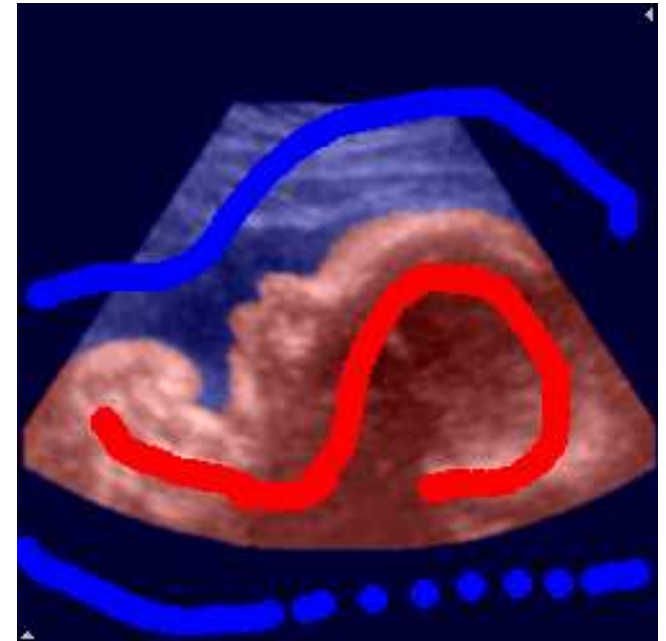

Current Research Challenge: AI versus Optimal Algorithms

Many image processing applications are currently taken over by **deep convolutional neural networks**.

- + Often better results
- + No ad-hoc definitions of s , t , c
- “Optimality” is thrown over board
- Lots of **training examples** needed

Is there a **middle way**?

Learn s , t , c then optimize?

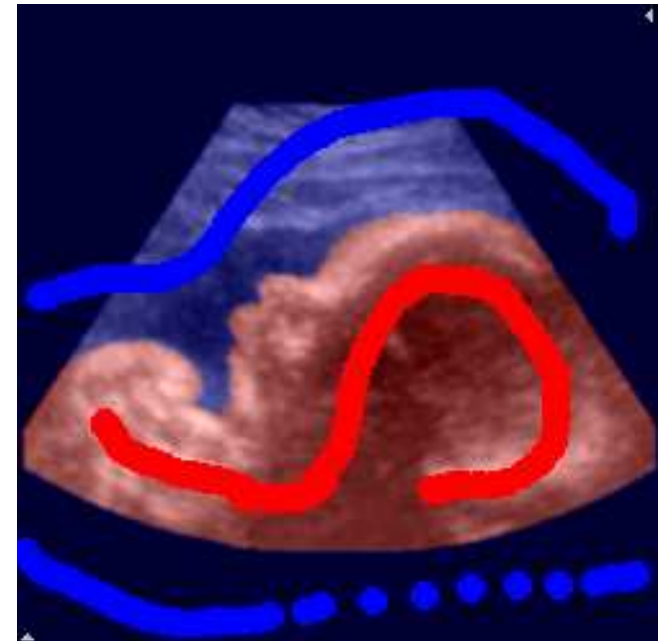

Applications in our Group

- multicasting using network coding
- balanced k partitioning
- disk scheduling

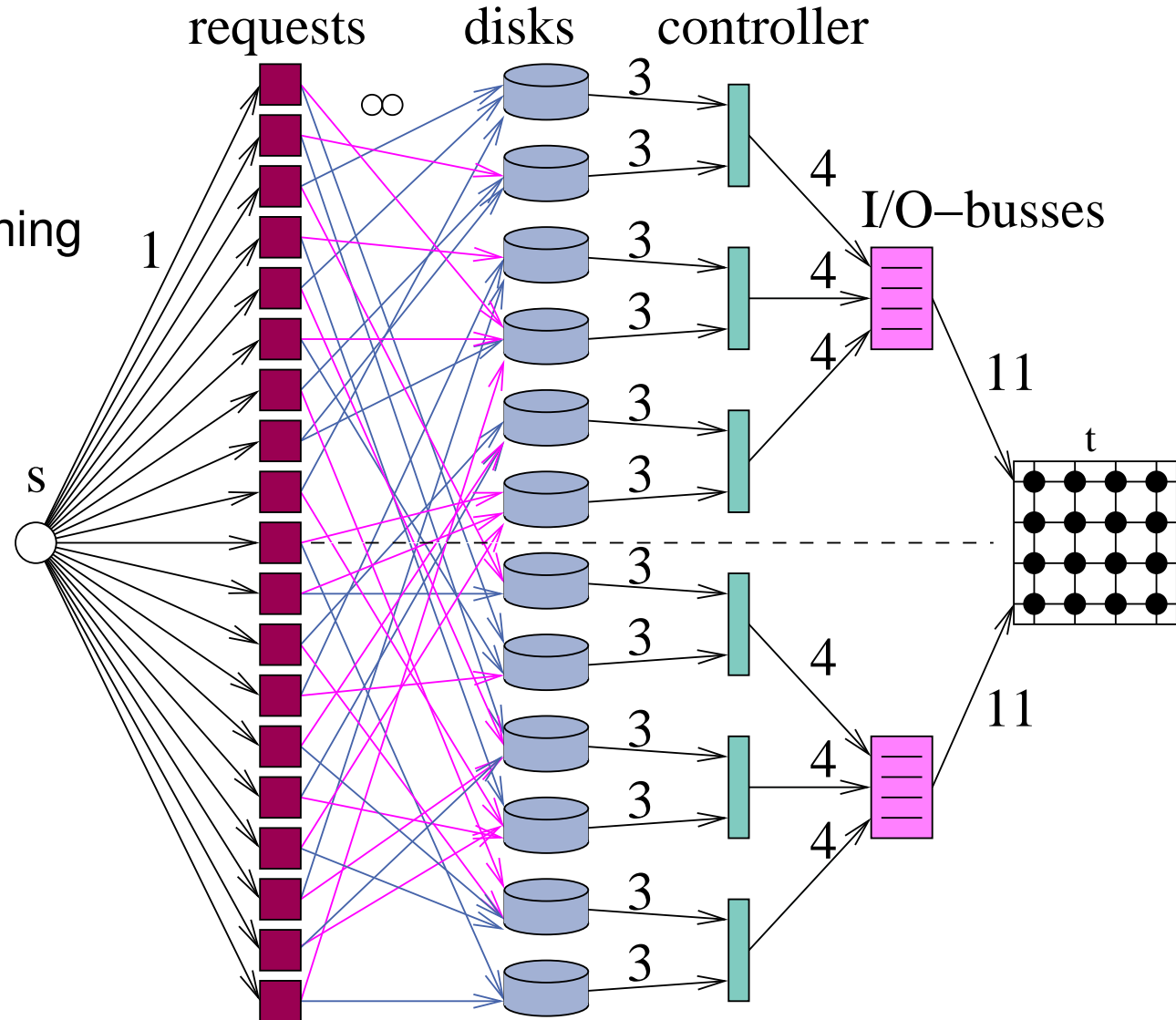

Option 1: linear programming

- Flow variables x_e for each edge e
- Flow on each edge is at most its capacity
- Incoming flow at each vertex = outgoing flow from this vertex
- Maximize outgoing flow from starting vertex

We can do better!

Algorithms 1956–now

Year	Author	Running time	
1956	Ford-Fulkerson	$O(mnU)$	
1969	Edmonds-Karp	$O(m^2n)$	
1970	Dinic	$O(mn^2)$	
1973	Dinic-Gabow	$O(mn \log U)$	n = number of nodes
1974	Karzanov	$O(n^3)$	m = number of arcs
1977	Cherkassky	$O(n^2 \sqrt{m})$	U = largest capacity
1980	Galil-Naamad	$O(mn \log^2 n)$	
1983	Sleator-Tarjan	$O(mn \log n)$	

Year	Author	Running time
1986	Goldberg-Tarjan	$O(mn \log(n^2/m))$
1987	Ahuja-Orlin	$O(mn + n^2 \log U)$
1987	Ahuja-Orlin-Tarjan	$O(mn \log(2 + n\sqrt{\log U}/m))$
1990	Cheriyon-Hagerup-Mehlhorn	$O(n^3 / \log n)$
1990	Alon	$O(mn + n^{8/3} \log n)$
1992	King-Rao-Tarjan	$O(mn + n^{2+\epsilon})$
1993	Philipps-Westbrook	$O(mn \log n / \log \frac{m}{n} + n^2 \log^{2+\epsilon} n)$
1994	King-Rao-Tarjan	$O(mn \log n / \log \frac{m}{n \log n})$ if $m \geq 2n \log n$
1997	Goldberg-Rao	$O(\min\{m^{1/2}, n^{2/3}\} m \log(n^2/m) \log U)$
2014	Lee-Sidford	$O(m\sqrt{n} \log^2 U)$

Augmenting Paths (Rough Idea)

Find a path from s to t such that each edge has some **spare capacity**

On this path, **saturate** the edge with the smallest spare capacity

Adjust capacities for all edges (create **residual graph**) and repeat

A typical **greedy algorithm**

Example

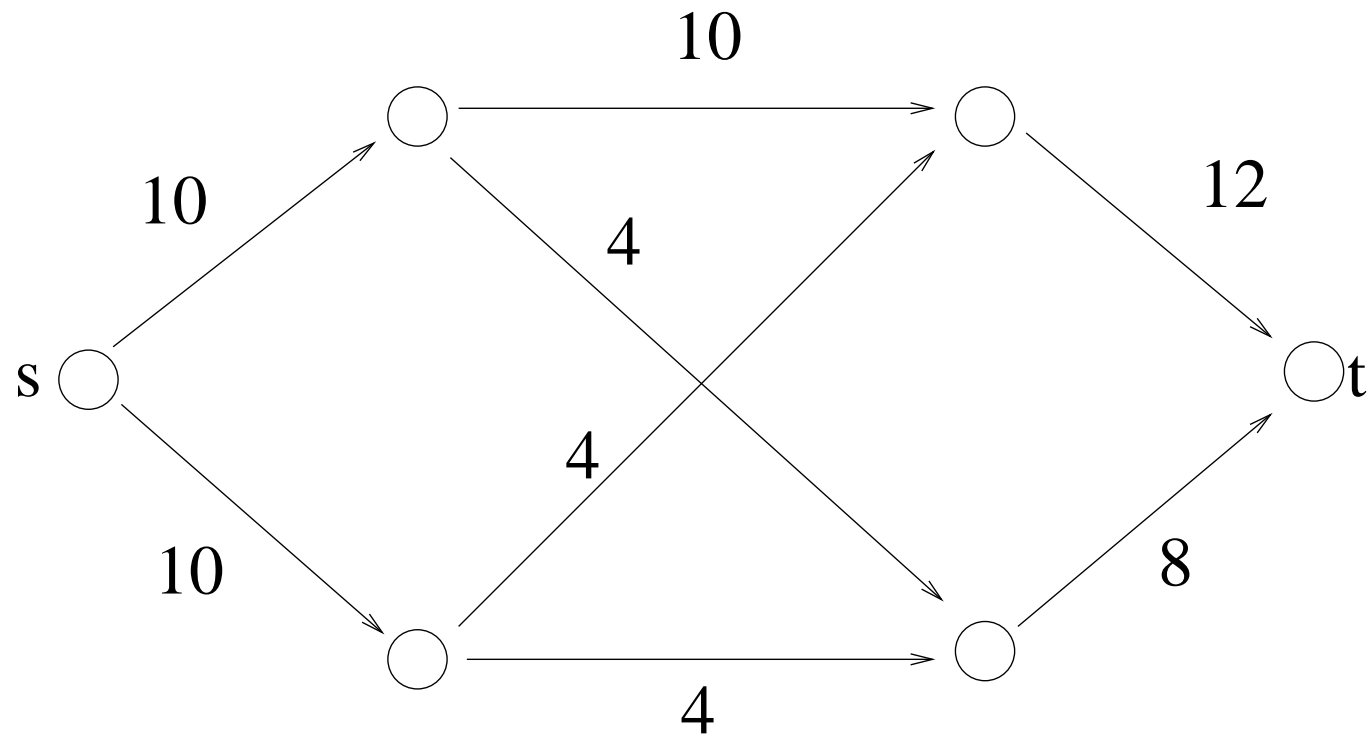

Example

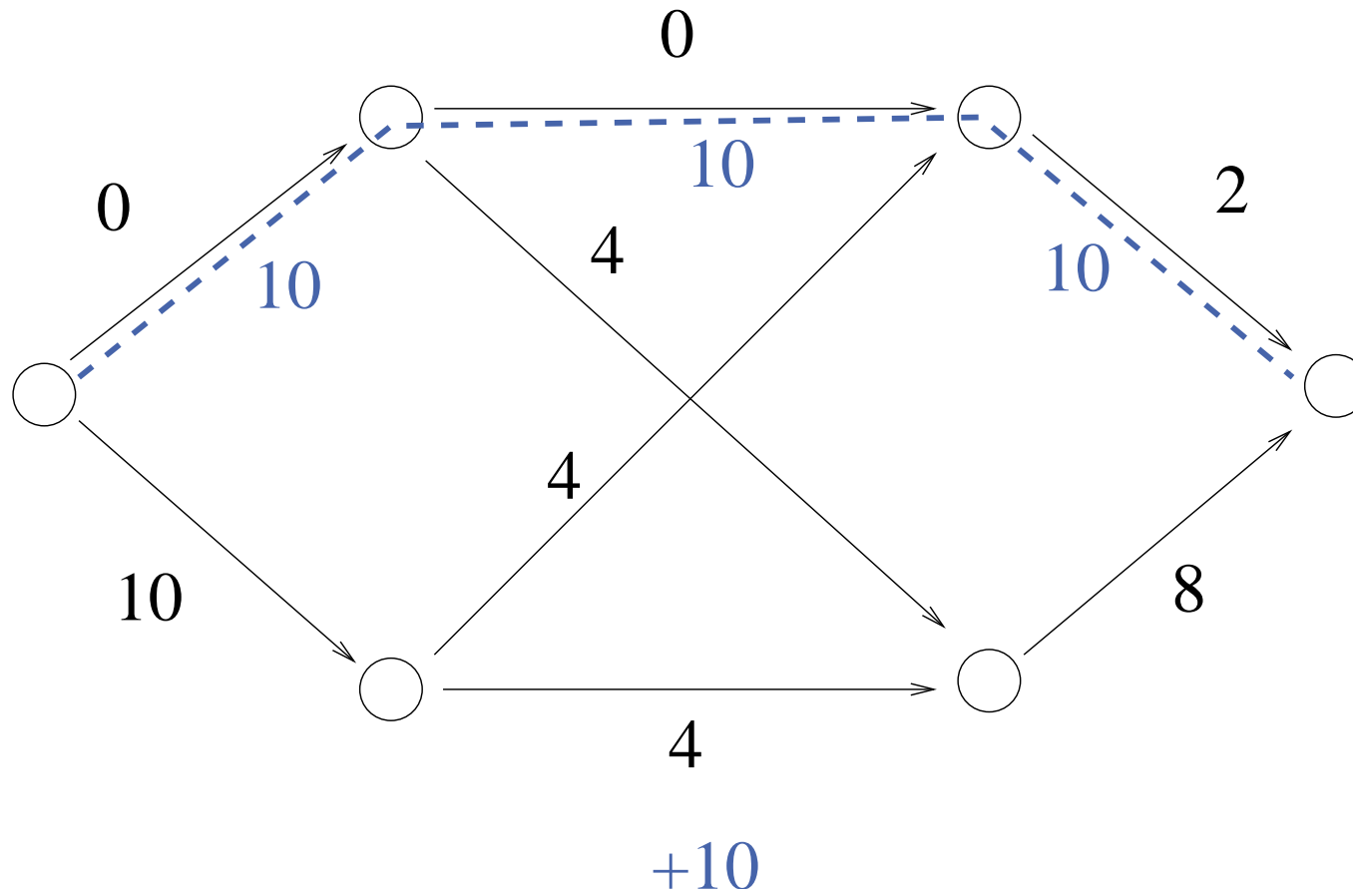

Example

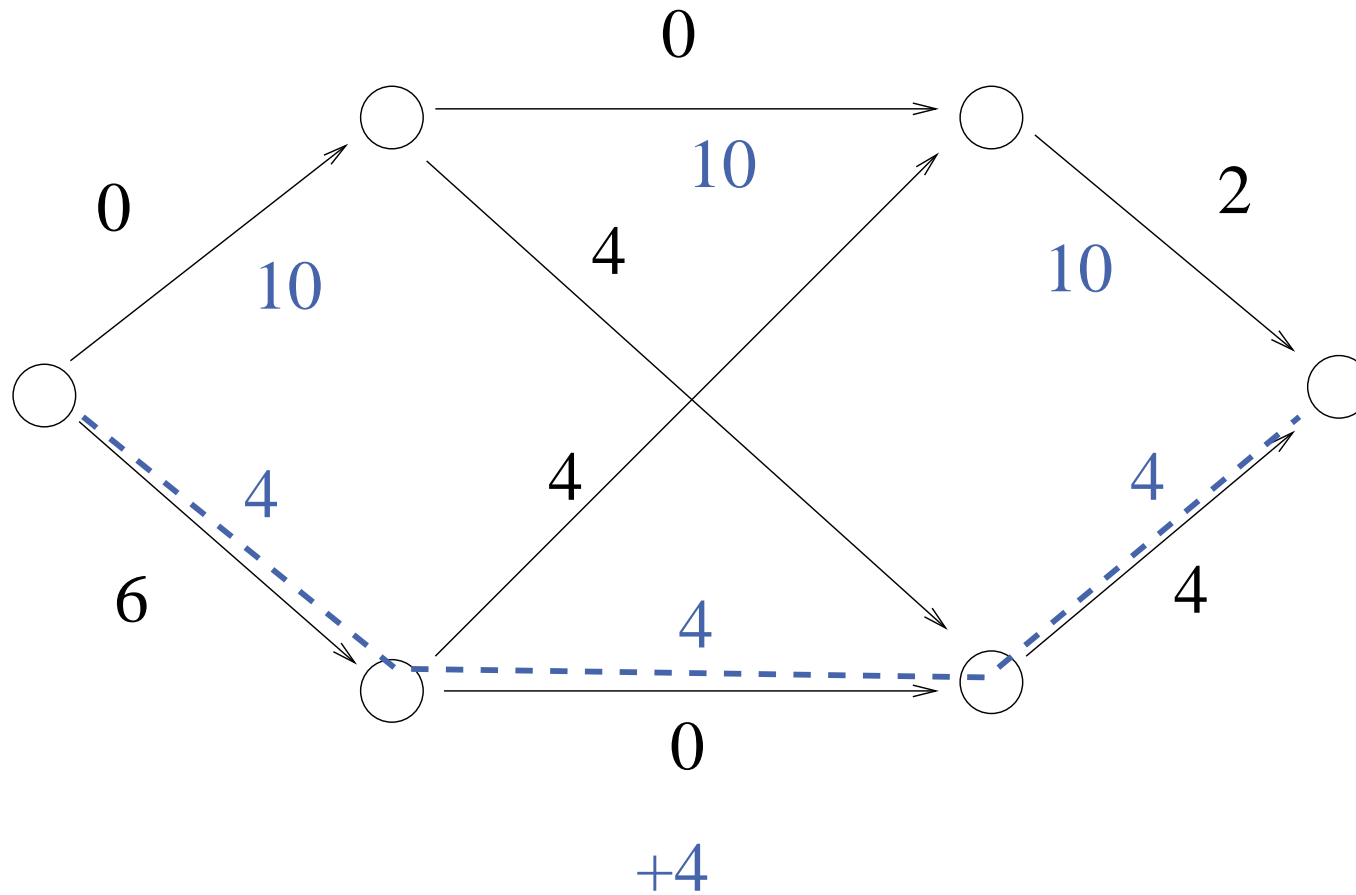

Example

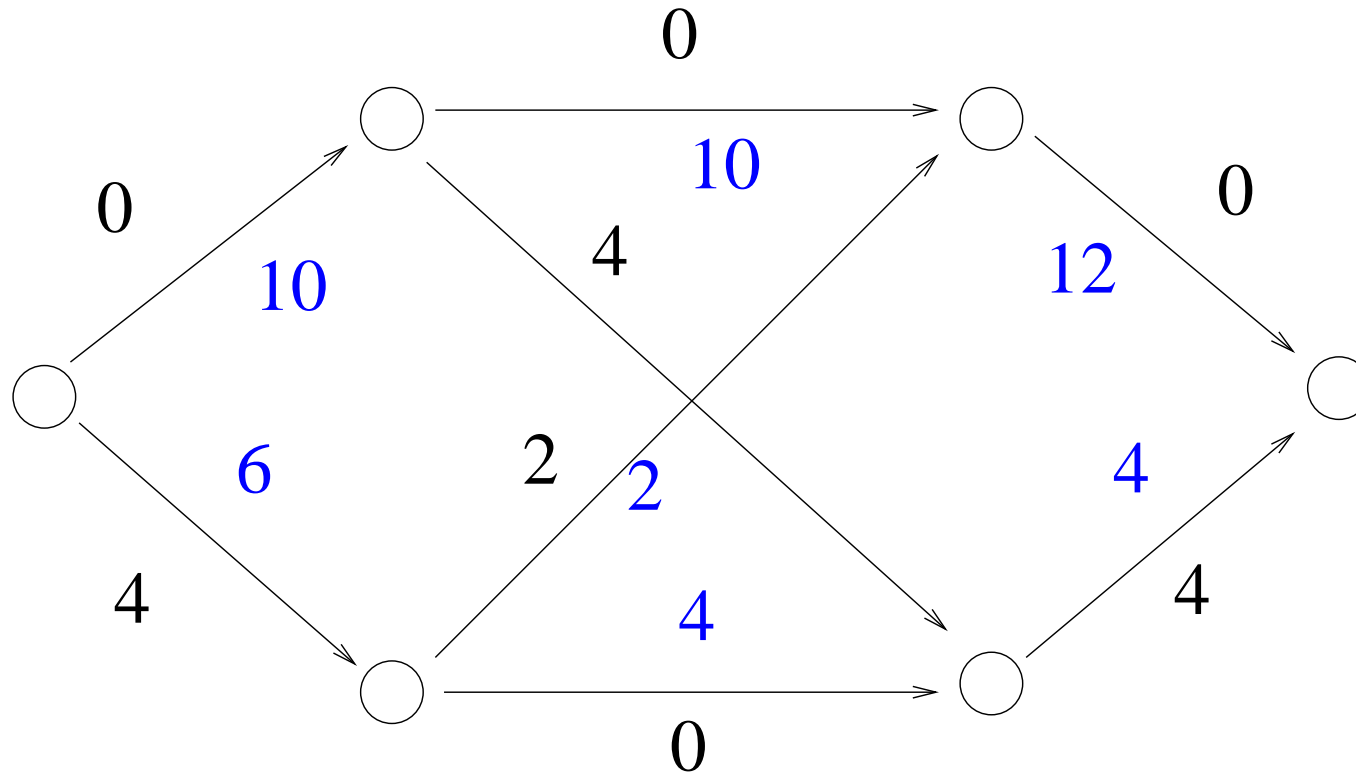

are we done?

Example

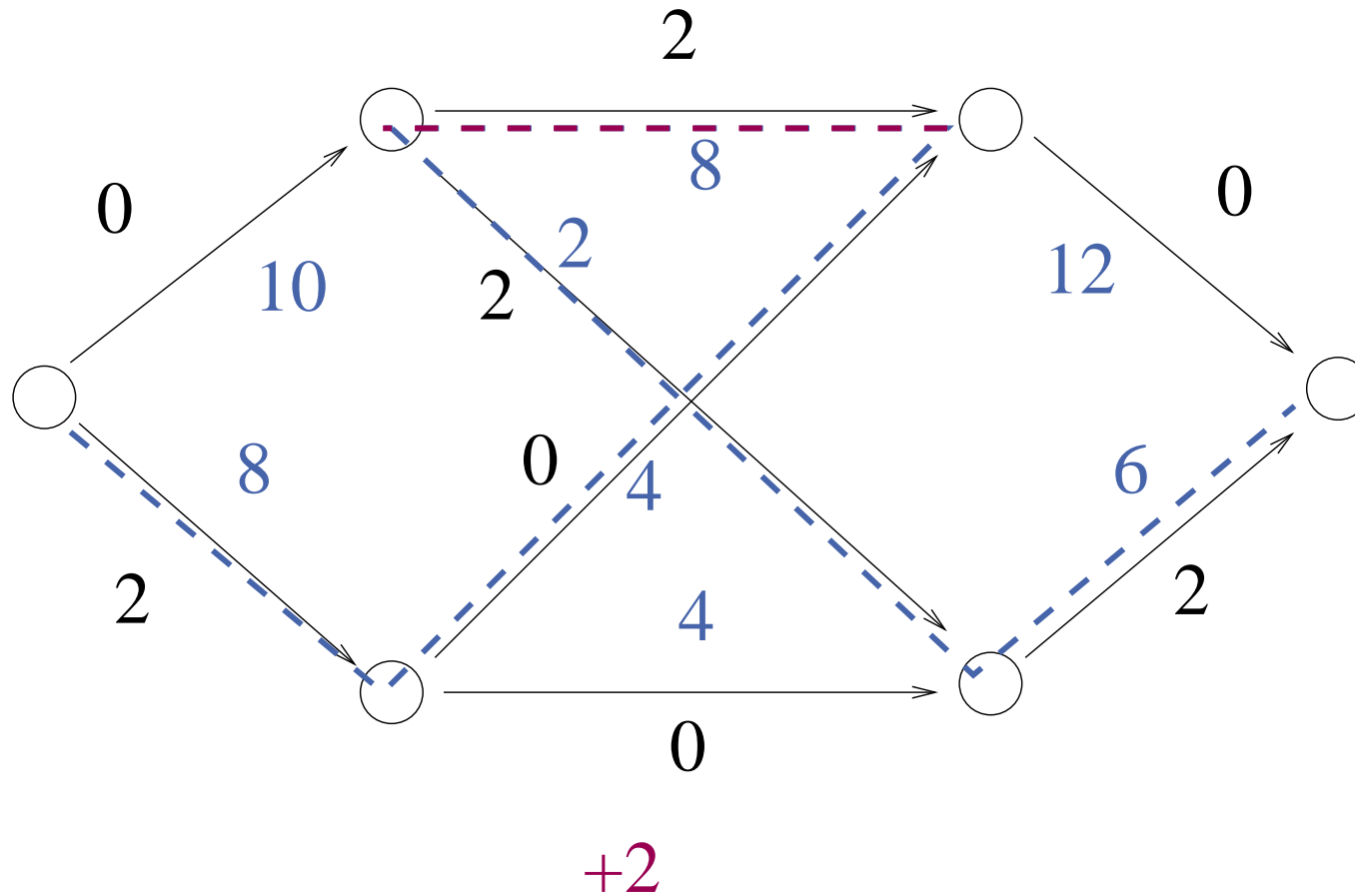

Residual Graph

Given, network $G = (V, E, c)$, flow f

Residual graph $G_f = (V, E_f, c^f)$. For each $e \in E$ we have

$$\begin{cases} e \in E_f \text{ with } c_e^f = c_e - f(e) & \text{if } f(e) < c(e) \\ e^{\text{rev}} \in E_f \text{ with } c_{e^{\text{rev}}}^f = f(e) & \text{if } f(e) > 0 \end{cases}$$

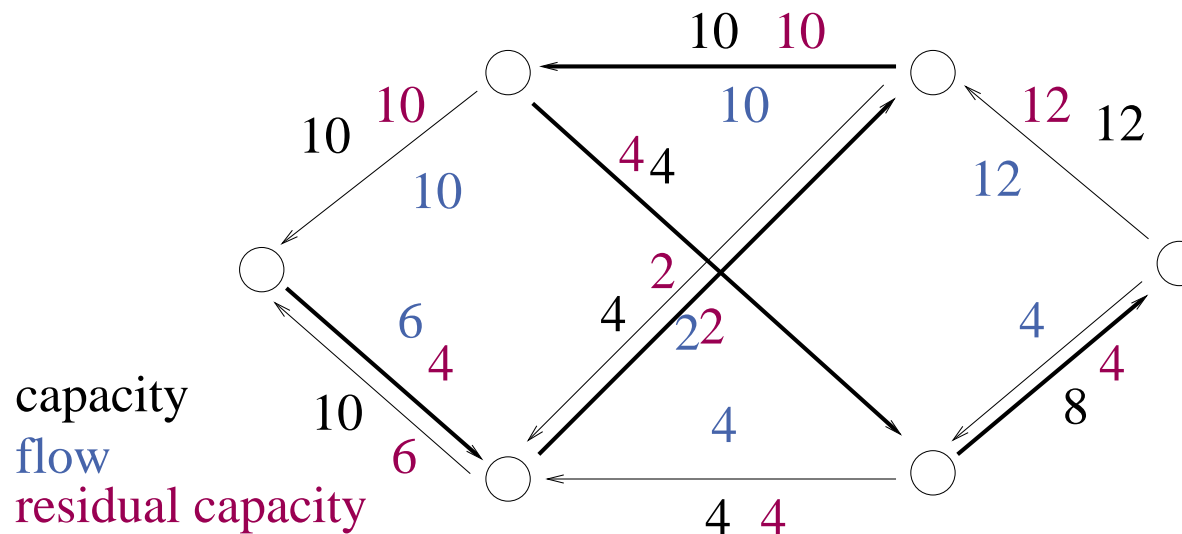

Augmenting Paths

Find a path p from s to t such that each edge e has nonzero residual capacity c_e^f

$$\Delta f := \min_{e \in p} c_e^f$$

foreach $(u, v) \in p$ **do**

if $(u, v) \in E$ **then** $f_{(u,v)} + = \Delta f$

else $f_{(v,u)} - = \Delta f$

Ford Fulkerson Algorithm

Function $\text{FFMaxFlow}(G = (V, E), s, t, c : E \rightarrow \mathbb{N}) : E \rightarrow \mathbb{N}$

$f := 0$

while \exists path $p = (s, \dots, t)$ in G_f **do**

 augment f along p

return f

time $O(m \cdot \text{val}(f))$

Ford Fulkerson – Correctness

“Clearly” FF computes a feasible flow f . (Invariant)

Todo: flow value is **maximal**

At termination: no augmenting paths in G_f left.

Consider cut $(S, T := V \setminus S)$ with

$S := \{v \in V : v \text{ reachable from } s \text{ in } G_f\}$

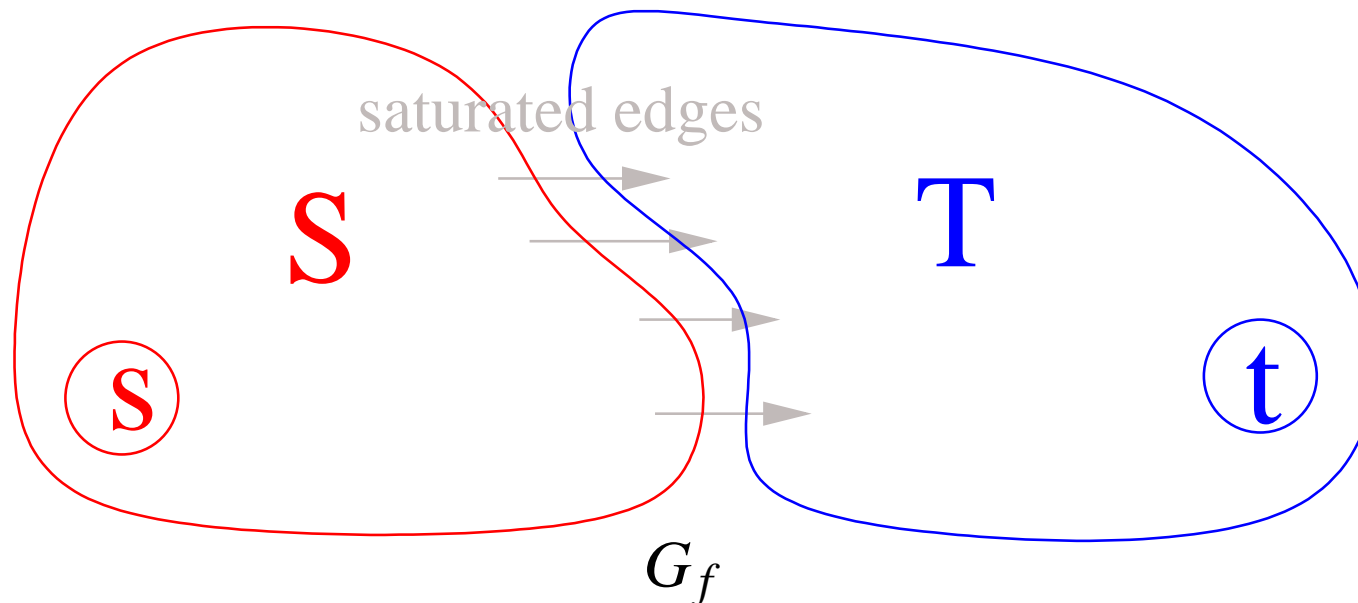

A Basic Observations

Lemma 1: For any cut (S, T) :

$$\mathbf{val}(f) = \overbrace{\sum_{e \in E \cap S \times T} f_e}^{S \rightarrow T \text{ edges}} - \overbrace{\sum_{e \in E \cap T \times S} f_e}^{T \rightarrow S \text{ edges}} .$$

Ford Fulkerson – Correctness

Todo: $\text{val}(f)$ is **maximal** when no augmenting paths in G_f left.

Consider cut $(S, T := V \setminus S)$ with

$S := \{v \in V : v \text{ reachable from } s \text{ in } G_f\}$.

Observation: $\forall (u, v) \in E \cap T \times S : f(u, v) = 0$

otherwise $c^f(v, u) > 0$ contradicting the definition of S .

$$\text{val}(f) = \sum_{e \in E \cap S \times T} f_e - \sum_{e \in E \cap T \times S} f_e \quad \text{Lemma 1}$$

$$= \sum_{e \in E \cap S \times T} f_e \quad \text{Observation above}$$

$$= \sum_{e \in E \cap S \times T} c_{(u,v)} = (S, T) \text{ cut capacity}$$

see next slide

Max-Flow-Min-Cut theorem

Theorem: Max-flow = min-cut

Proof:

obvious: any-flow \leq max-flow \leq min-cut \leq any-cut

previous slide:

(S, T) flow = (S, T) cut capacity

\Rightarrow

(S, T) flow = max-flow = min-cut

A Bad Example for Ford Fulkerson

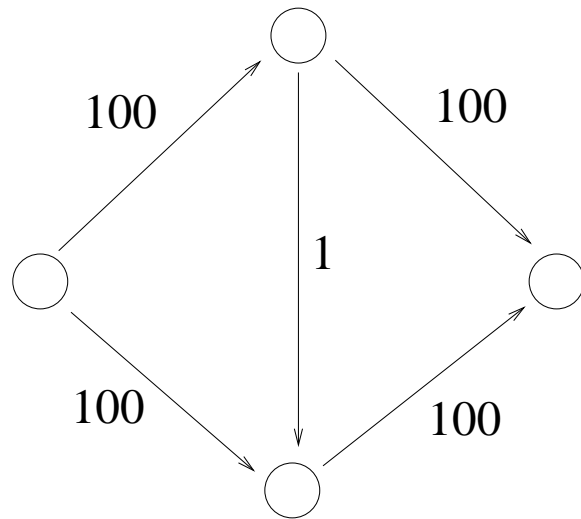

A Bad Example for Ford Fulkerson

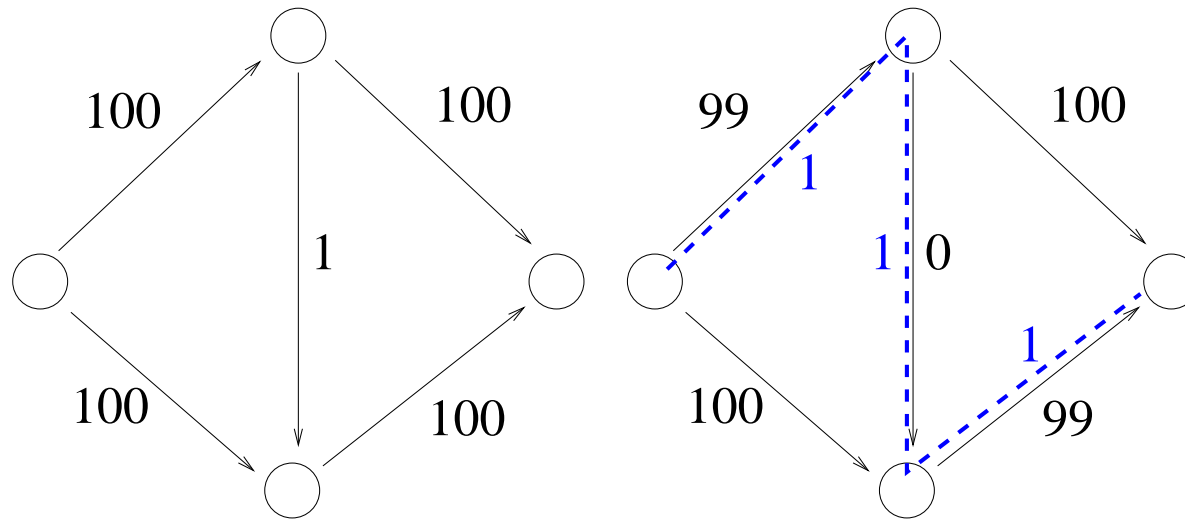

A Bad Example for Ford Fulkerson

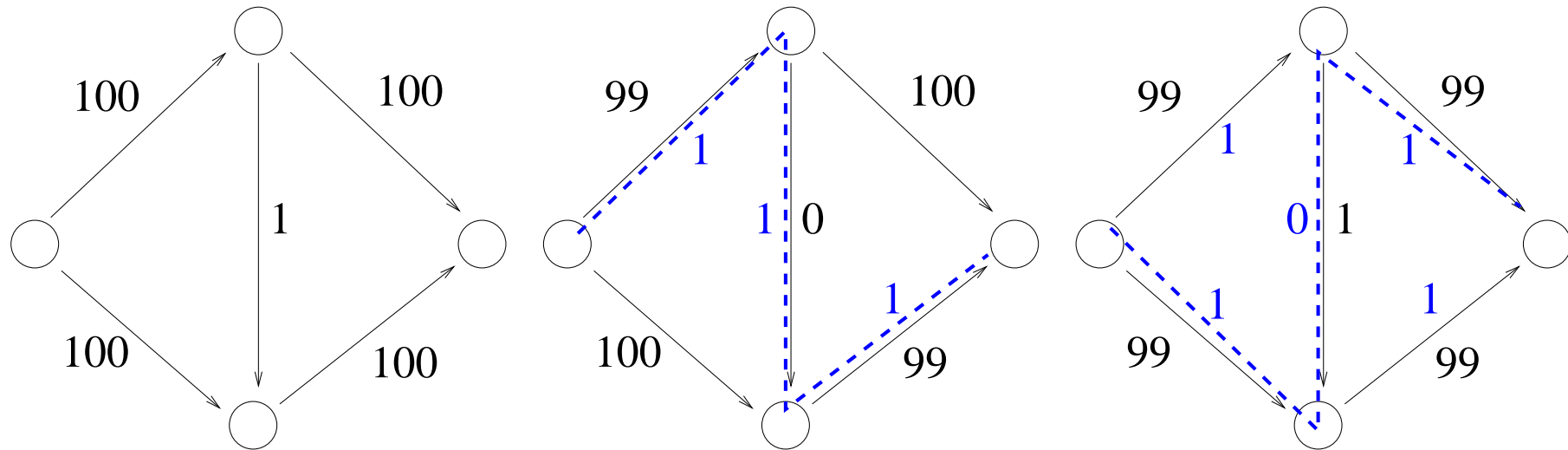

An Even Worse Example for Ford Fulkerson

[U. Zwick, TCS 148, p. 165–170, 1995]

$$\text{Let } r = \frac{\sqrt{5} - 1}{2}.$$

Consider the graph

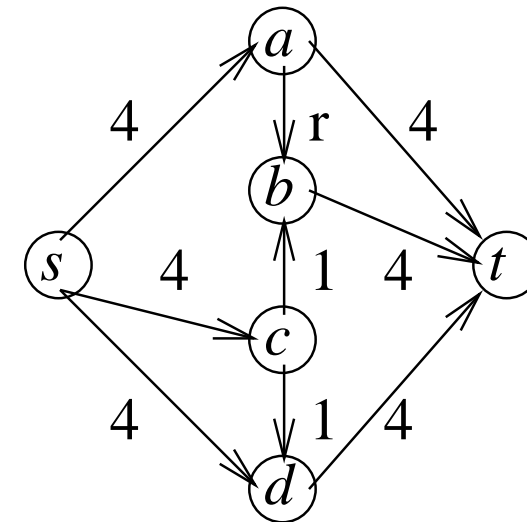

And the augmenting paths

$$p_0 = \langle s, c, b, t \rangle$$

$$p_1 = \langle s, a, b, c, d, t \rangle$$

$$p_2 = \langle s, c, b, a, t \rangle$$

$$p_3 = \langle s, d, c, b, t \rangle$$

The sequence of augmenting paths $p_0(p_1, p_2, p_1, p_3)^*$ is an infinite sequence of positive flow augmentations.

The flow value does **not** converge to the maximum value 9.

Blocking Flows

f_b is a **blocking flow** in H if

$$\forall \text{paths } p = \langle s, \dots, t \rangle : \exists e \in p : f_b(e) = c(e)$$

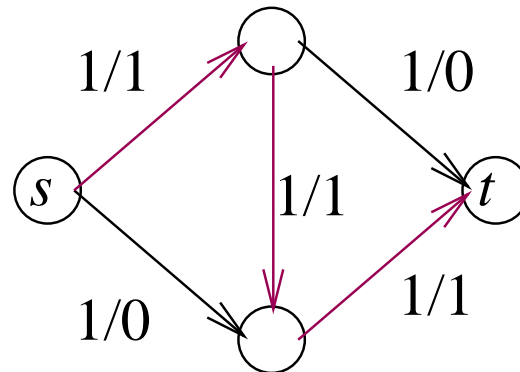

Dinitz Algorithm

Function DinitzMaxFlow($G = (V, E), s, t, c : E \rightarrow \mathbb{N}$) : $E \rightarrow \mathbb{N}$

$f := 0$

while \exists path $p = (s, \dots, t)$ in G_f **do**

$d = G_f.\text{reverseBFS}(t) : V \rightarrow \mathbb{N}$

$L_f = (V, \{(u, v) \in E_f : d(v) = d(u) - 1\})$ // layer graph

 find a **blocking flow** f_b in L_f

 augment $f += f_b$

return f

Dinitz – Correctness

analogous to Ford-Fulkerson

Example

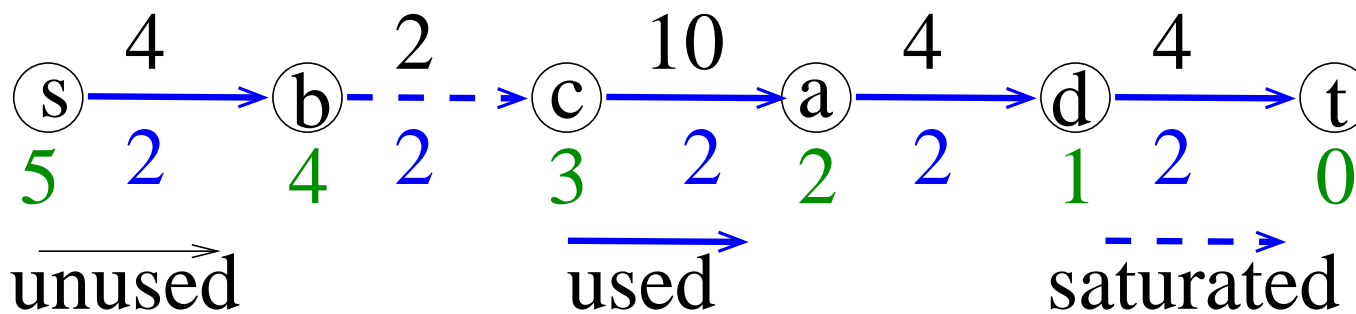
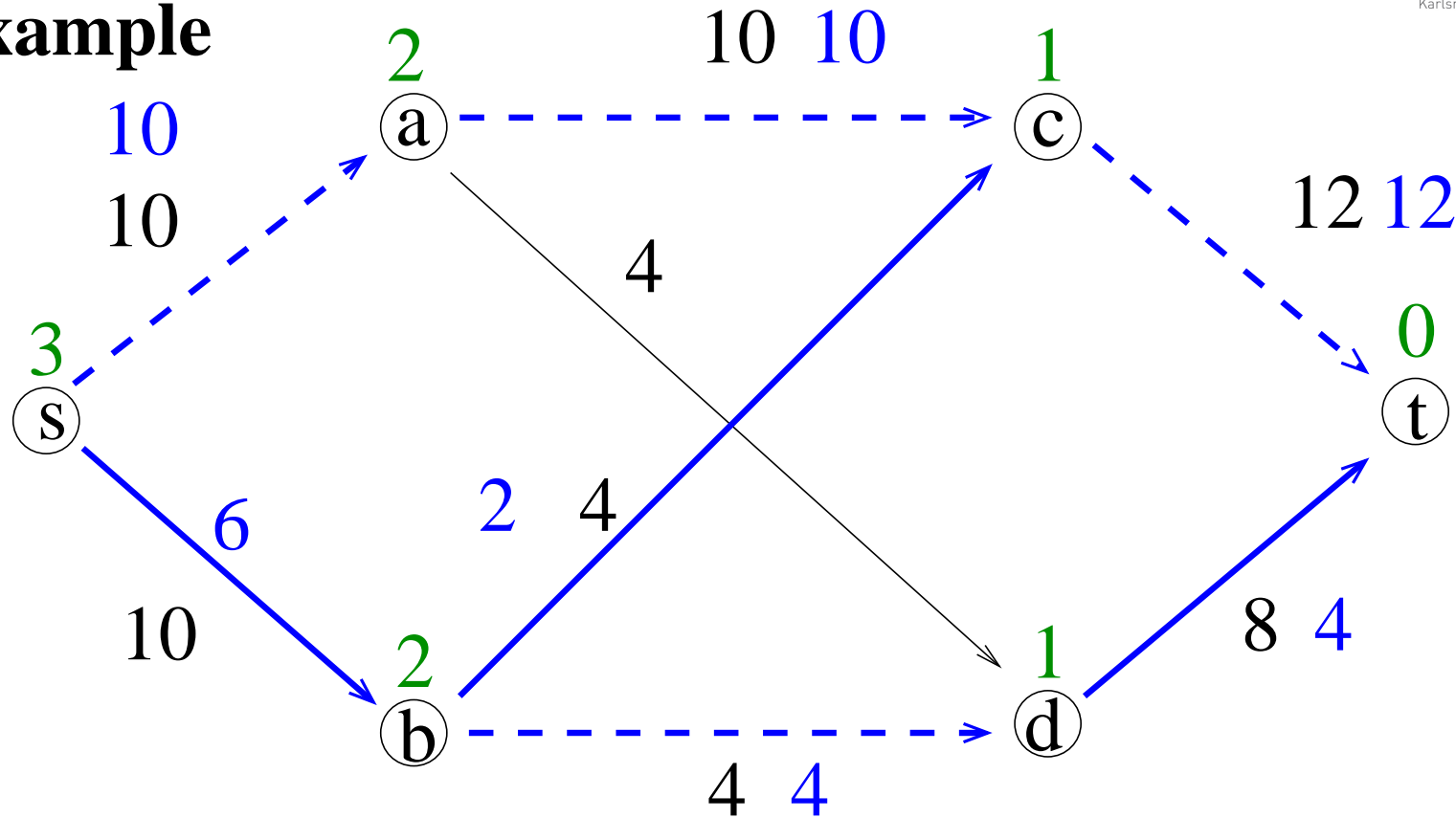

Computing Blocking Flows

Idee: wiederholte DFS nach augmentierenden Pfaden

Function blockingFlow($L_f = (V, E)$) : $E \rightarrow \mathbb{N}$

$p = \langle s \rangle$: Path; $f_b = 0$: Flow

loop

// Round

$v := p.last()$

if $v = t$ **then**

// breakthrough

$\delta := \min \{c(e) - f_b(e) : e \in p\}$

foreach $e \in p$ **do**

$f_b(e) += \delta$

if $f_b(e) = c(e)$ **then** **remove** e from E

$p := \langle s \rangle$

else if $\exists e = (v, w) \in E$ **then** $p.pushBack(w)$

// extend

else if $v = s$ **then return** f_b

// done

else delete the last edge from p in p and E

// retreat

Example

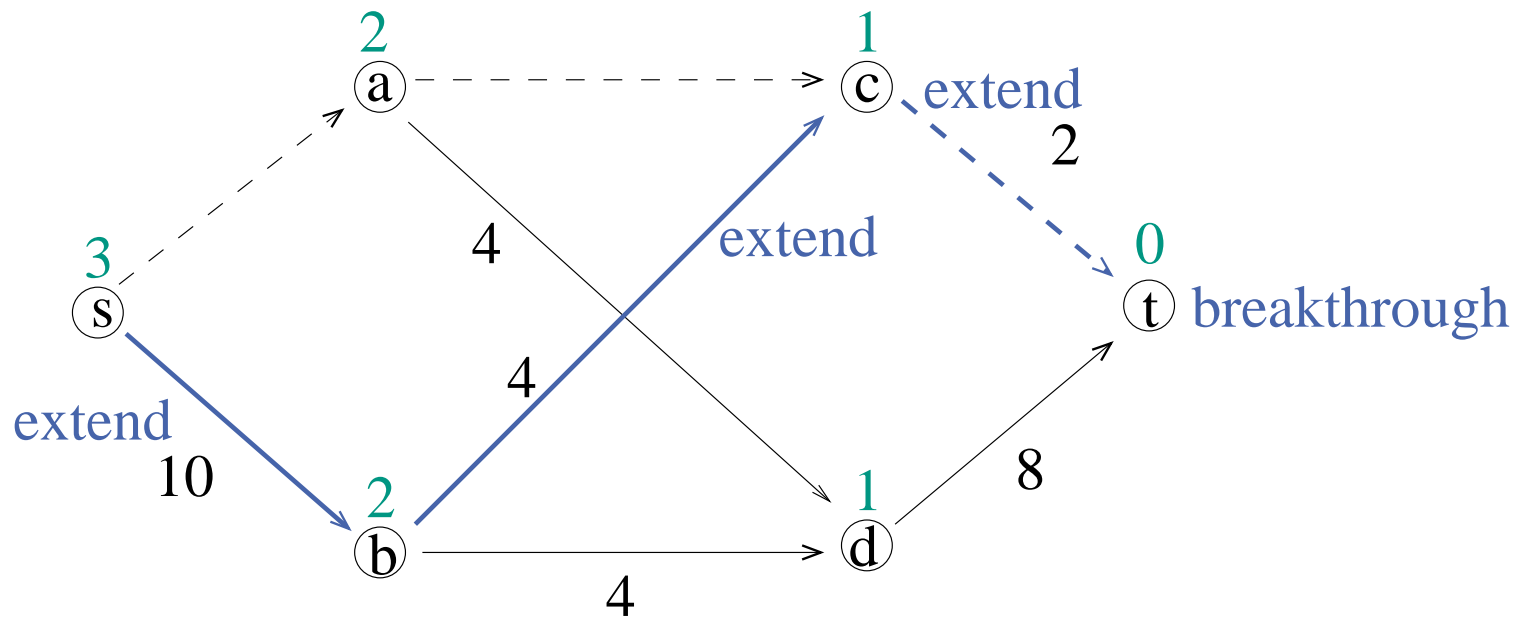
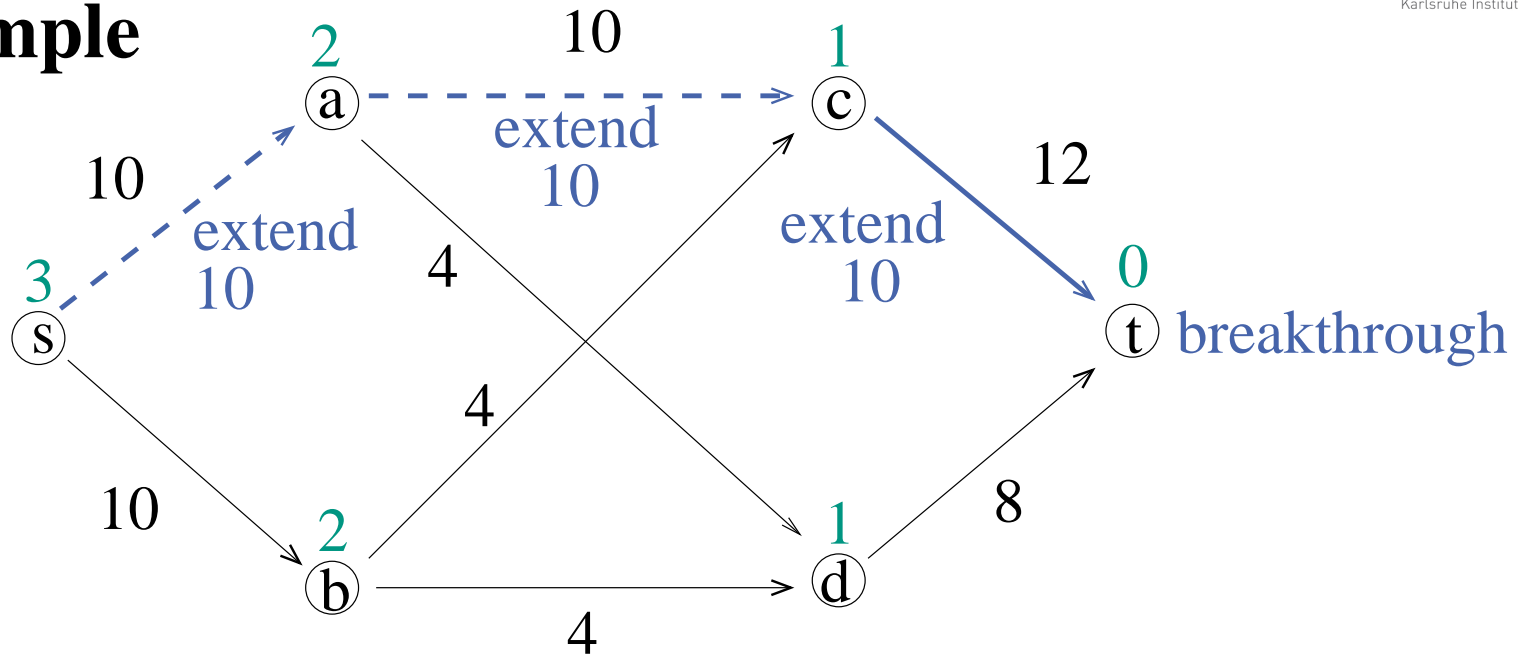

Example

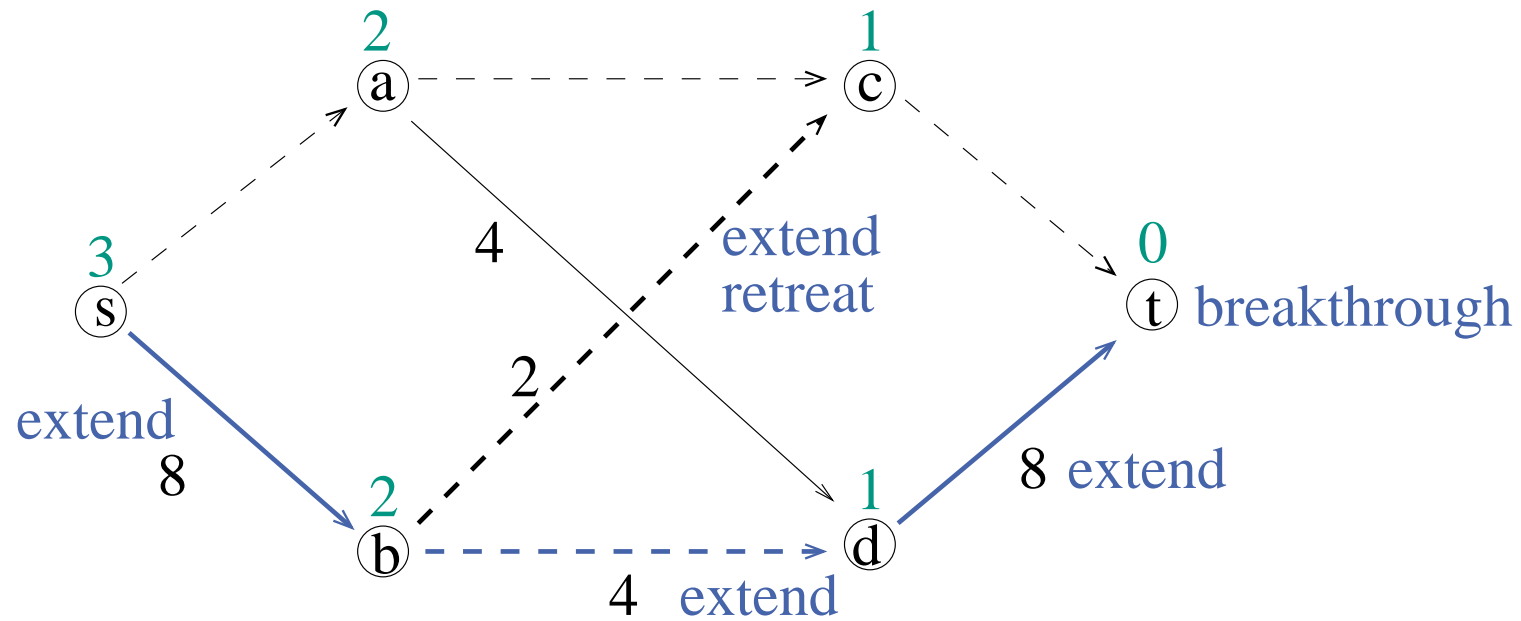
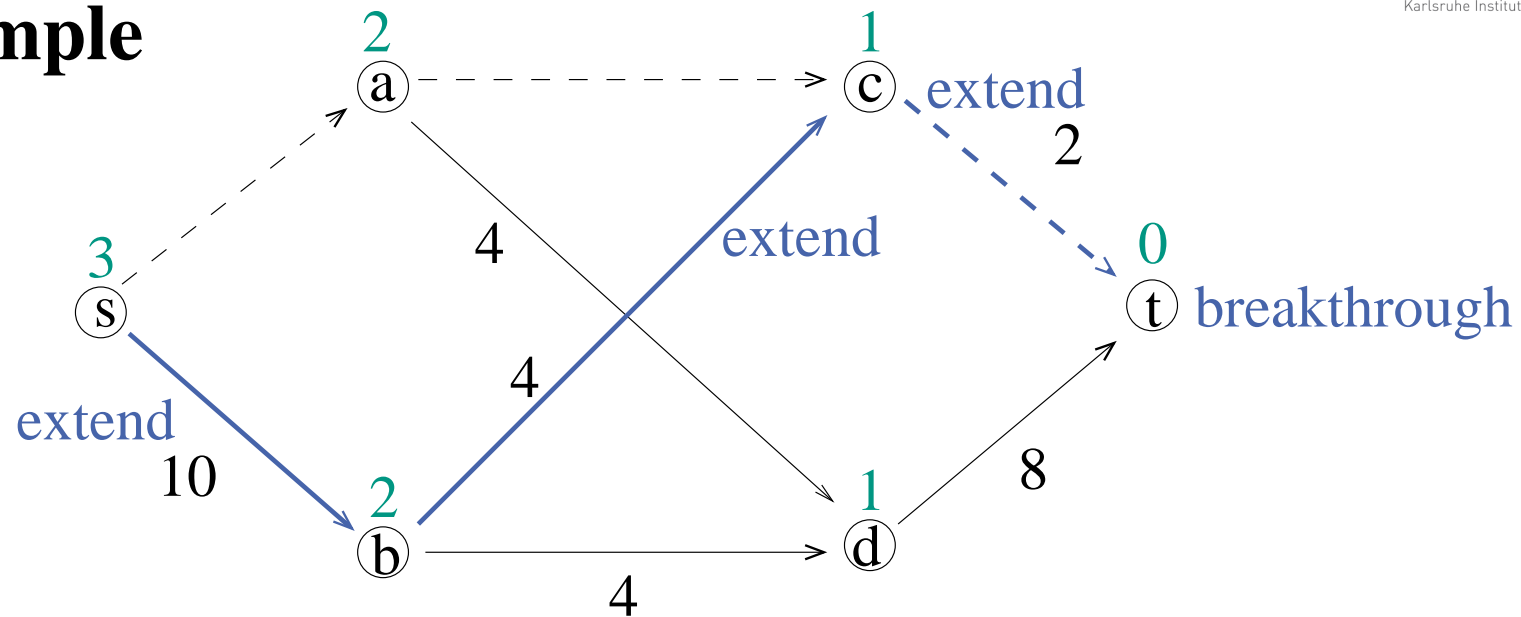

Example

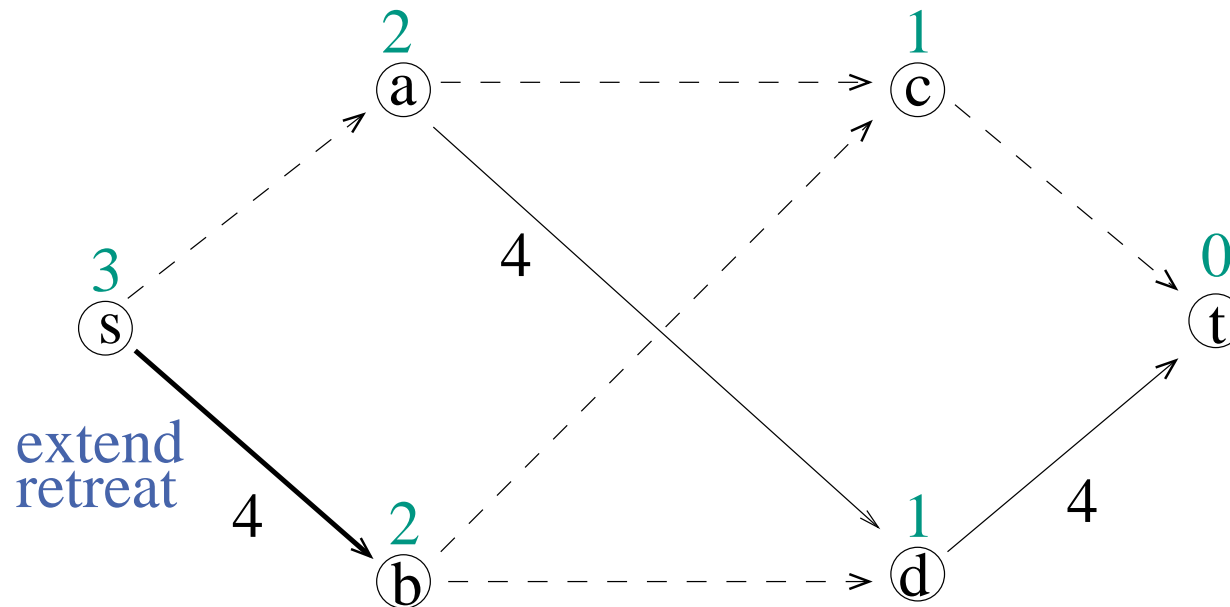
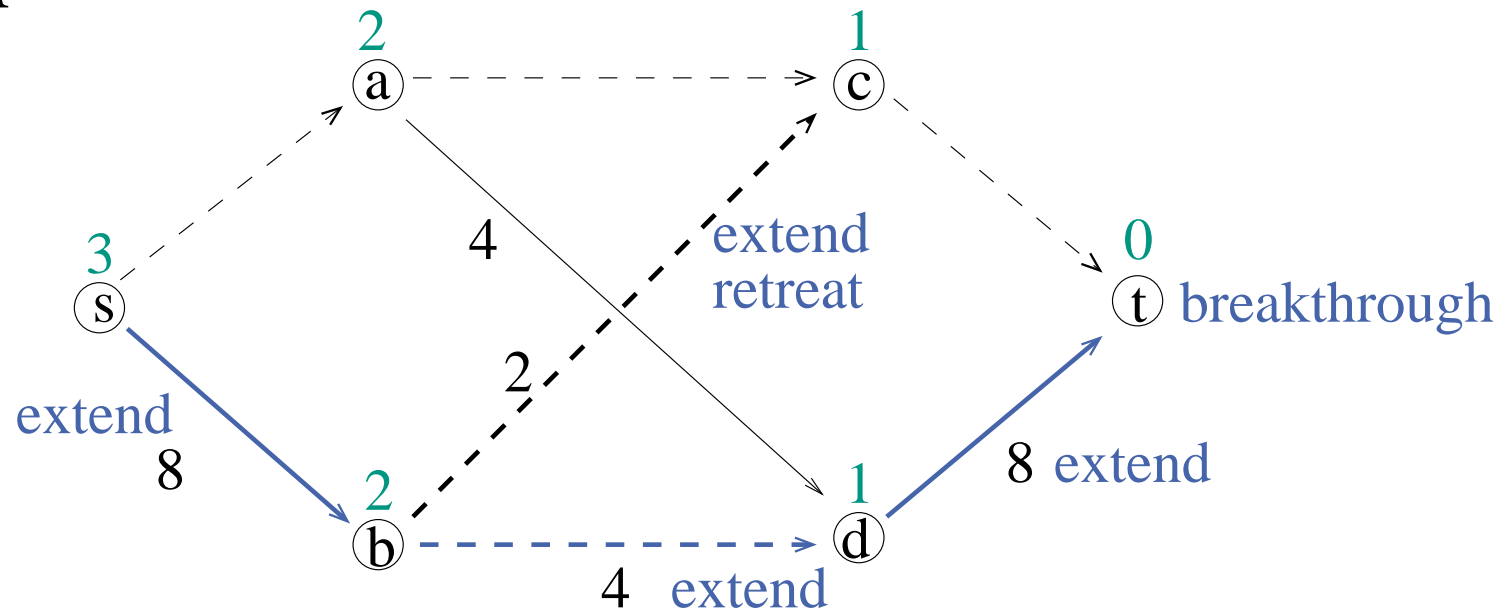

Blocking Flows Analysis 1

- running time $\#_{extends} + \#_{retreats} + n \cdot \#_{breakthroughs}$
- $\#_{breakthroughs} \leq m$ – ≥ 1 edge is saturated
- $\#_{retreats} \leq m$ – one edge is removed
- $\#_{extends} \leq \#_{retreats} + n \cdot \#_{breakthroughs}$
 - a retreat cancels 1 extend, a breakthrough cancels $\leq n$ extends

time is $O(m + nm) = O(nm)$

Blocking Flows Analysis 2

Unit capacities:

breakthroughs saturates **all** edges on p , i.e., amortized constant cost per edge.

time $O(m + n)$

Blocking Flows Analysis 3

Dynamic trees: breakthrough (!), retreat, extend in time $O(\log n)$

time $O((m + n) \log n)$

“Theory alert”: In practice, this seems to be slower
(few breakthroughs, many retreat, extend ops.)

Dinitz Analysis 1

Lemma 1. *$d(s)$ increases by at least one in each round.*

Beweis. not here



Dinitz Analysis 2

□ $\leq n$ rounds

□ time $O(mn)$ each

time $O(mn^2)$ (strongly polynomial)

time $O(mn \log n)$ with dynamic trees

Dinitz Analysis 3 – Unit Capacities

Lemma 2. *At most $2\sqrt{m}$ BF computations:*

Beweis. Consider iteration $k = \sqrt{m}$.

Cut in layergraph induces cut in residual graph of capacity at most \sqrt{m} .

At most \sqrt{m} additional phases.

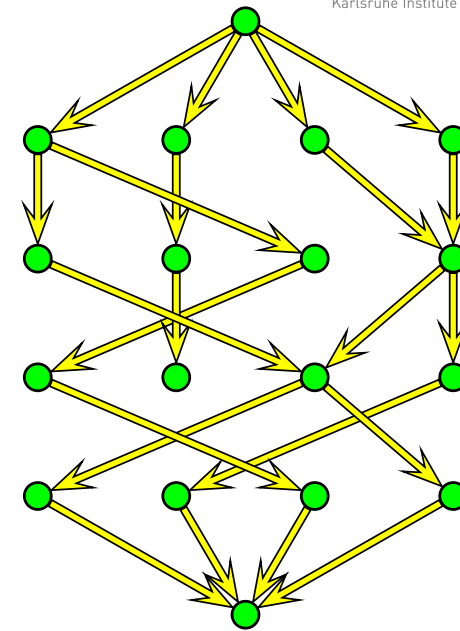

Total time: $O((m + n)\sqrt{m})$

more detailed analysis: $O\left(m \min \left\{ m^{1/2}, n^{2/3} \right\}\right)$

Dinitz Analysis 4 – Unit Networks

Unit capacity + $\forall v \in V : \min \{ \text{indegree}(v), \text{outdegree}(v) \} = 1$:

time: $O((m+n)\sqrt{n})$

Matching

$M \subseteq E$ is a **matching** in the undirected graph $G = (V, E)$ iff (V, M) has maximum degree ≤ 1 .

M is **maximal** if $\nexists e \in E \setminus M : M \cup \{e\}$ is a matching.

M has **maximum** cardinality if \nexists matching $M' : |M'| > |M|$

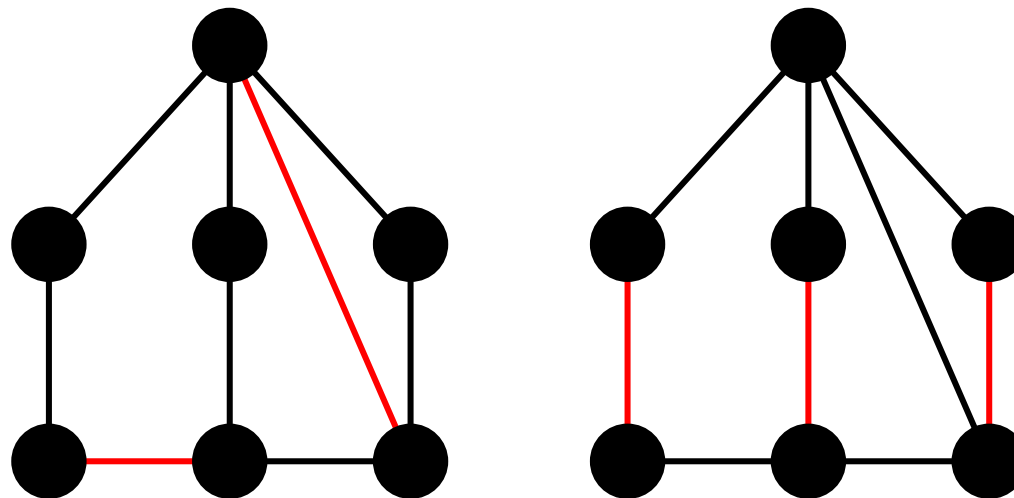

Maximum Cardinality Bipartite Matching

in $(L \cup R, E)$. Model as a **unit network maximum flow** problem

$$(\{s\} \cup L \cup R \cup \{t\}, \{(s, u) : u \in L\} \cup E \cup \{(v, t) : v \in R\})$$

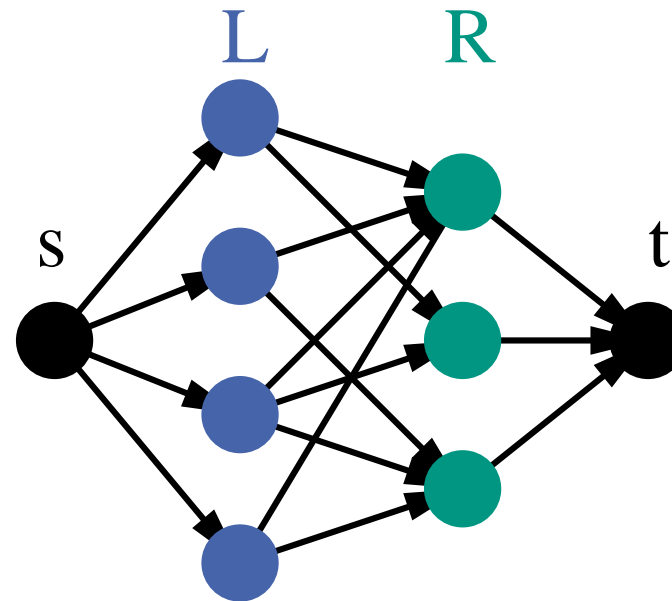

Dinitz algorithm yields $O((n + m)\sqrt{n})$ algorithm

Similar Performance for Weighted Graphs?

time: $O\left(m \min\left\{m^{1/2}, n^{2/3}\right\} \log C\right)$ [Goldberg Rao 97]

Problem: Fat edges between layers ruin the argument

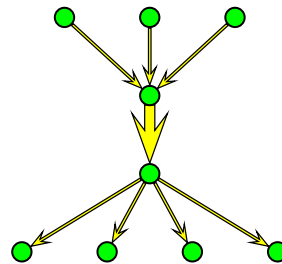

Idea: **scale** a parameter Δ from small to large
contract SCCs of fat edges (capacity $> \Delta$)

Experiments [Hagerup, Sanders Träff 98]:

Sometimes best algorithm usually slower than **preflow push**

Disadvantage of augmenting paths algorithms

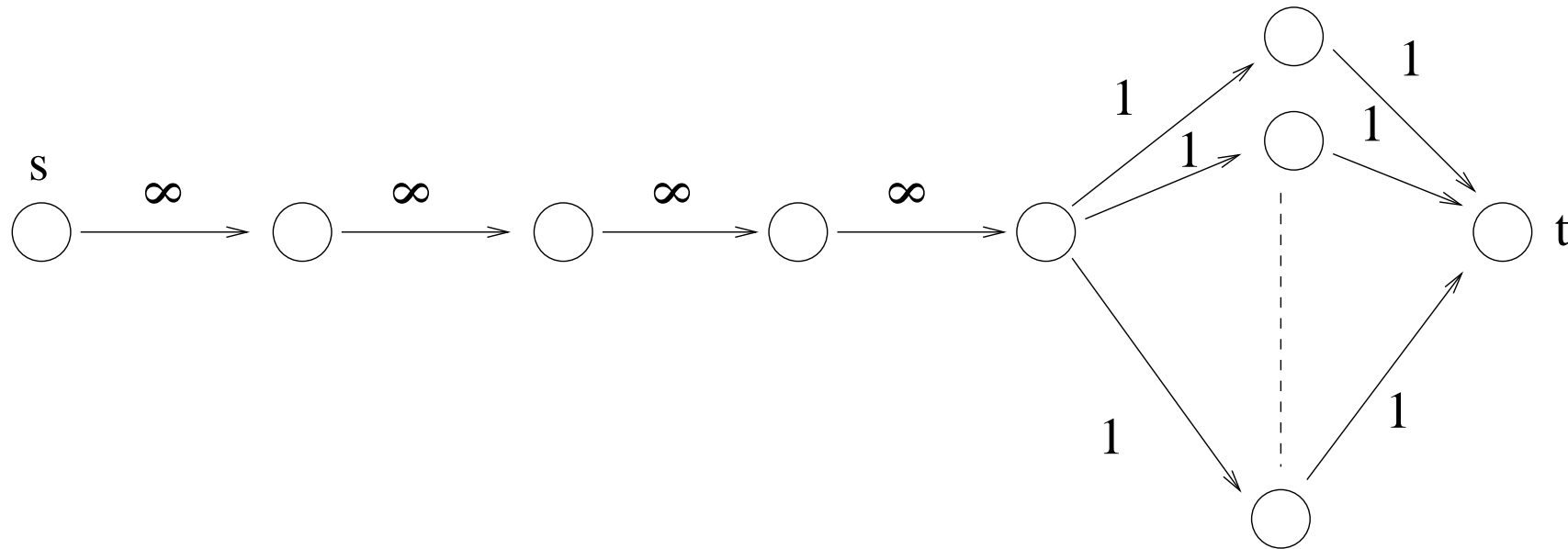

Preflow-Push Algorithms

Preflow f : a flow where the **flow conservation** constraint is **relaxed** to

$$\text{excess}(v) := \overbrace{\sum_{(u,v) \in E} f_{(u,v)}}^{\text{inflow}} - \overbrace{\sum_{(v,w) \in E} f_{(v,w)}}^{\text{outflow}} \geq 0 .$$

$v \in V \setminus \{s, t\}$ is **active** iff $\text{excess}(v) > 0$

Procedure $\text{push}(e = (v, w), \delta)$

assert $\delta > 0 \quad \wedge \quad \text{excess}(v) \geq \delta$

assert residual capacity of $e \geq \delta$

$\text{excess}(v) - = \delta$

$\text{excess}(w) + = \delta$

if e is reverse edge **then** $f(\text{reverse}(e)) - = \delta$

else $f(e) + = \delta$

Level Function

Idea: make progress by pushing **towards** t

Maintain

an **approximation** $d(v)$ of the BFS distance from v to t in G_f .

invariant $d(t) = 0$

invariant $d(s) = n$

invariant $\forall (v, w) \in E_f : d(v) \leq d(w) + 1$ // no **steep** edges

Edge directions of $e = (v, w)$

steep: $d(w) < d(v) - 1$

downward: $d(w) < d(v)$

horizontal: $d(w) = d(v)$

upward: $d(w) > d(v)$

```

Procedure genericPreflowPush( $G=(V,E)$ ,  $f$ )
  forall  $e = (s, v) \in E$  do push( $e, c(e)$ )           // saturate
   $d(s) := n$ 
   $d(v) := 0$  for all other nodes
  while  $\exists v \in V \setminus \{s, t\} : \text{excess}(v) > 0$  do           // active node
    if  $\exists e = (v, w) \in E_f : d(w) < d(v)$  then // eligible edge
      choose some  $\delta \leq \min \left\{ \text{excess}(v), c_e^f \right\}$ 
      push( $e, \delta$ ) // no new steep edges
    else  $d(v)++$  // relabel. No new steep edges
  
```

Obvious choice for δ : $\delta = \min \left\{ \text{excess}(v), c_e^f \right\}$

Saturating push: $\delta = c_e^f$

nonsaturating push: $\delta < c_e^f$

To be filled in: How to select active nodes and eligible edges?

Example

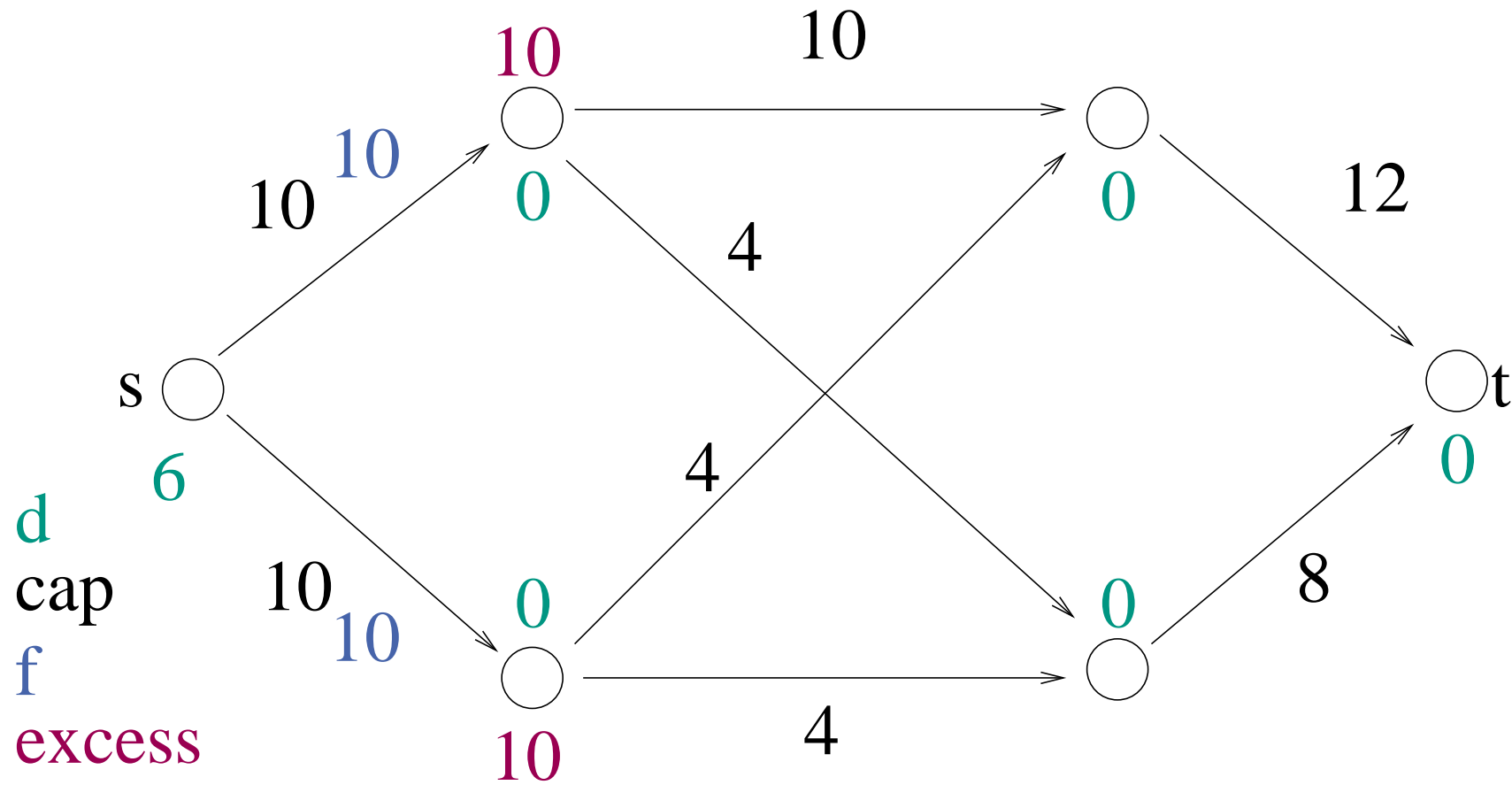

Example

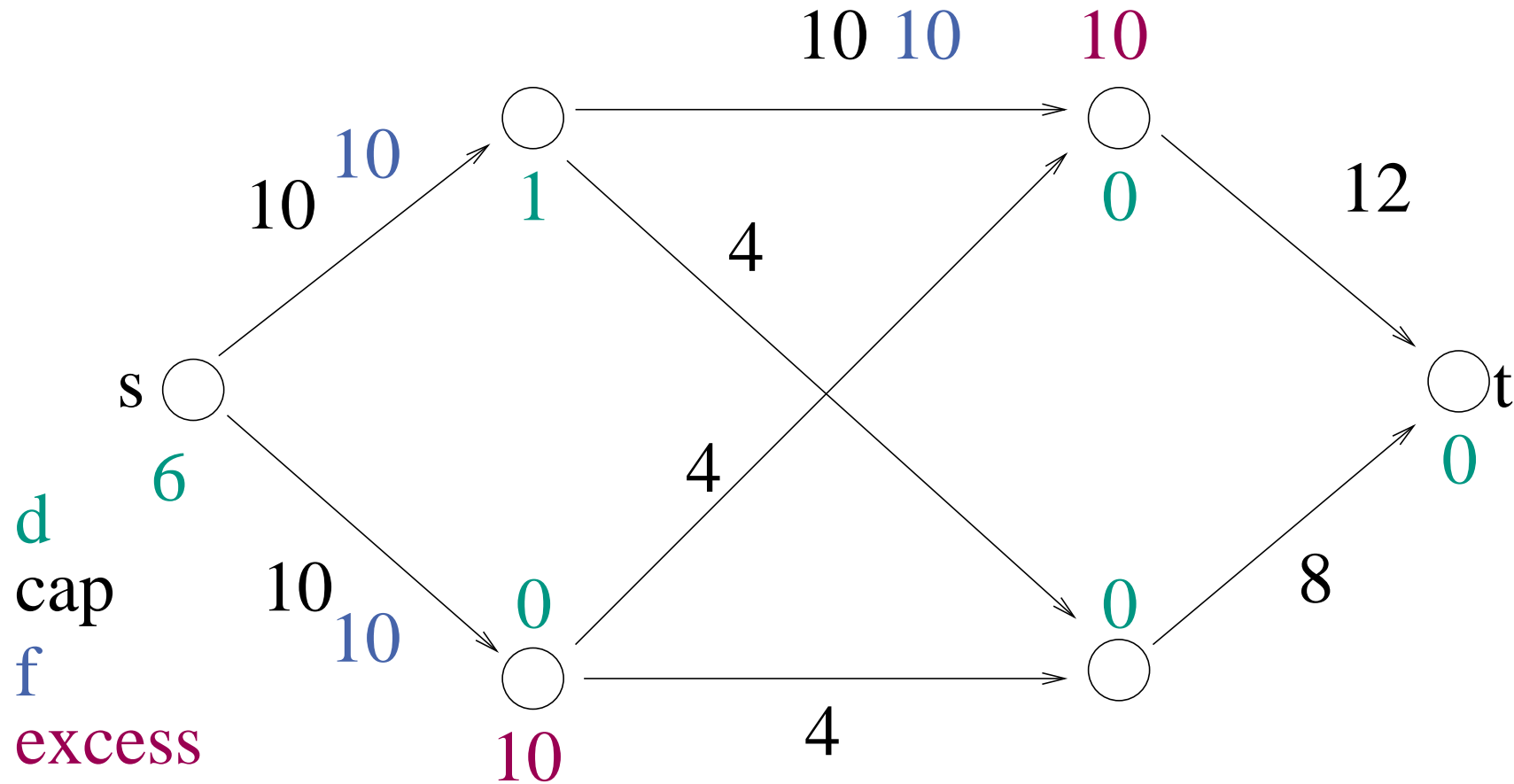

Example

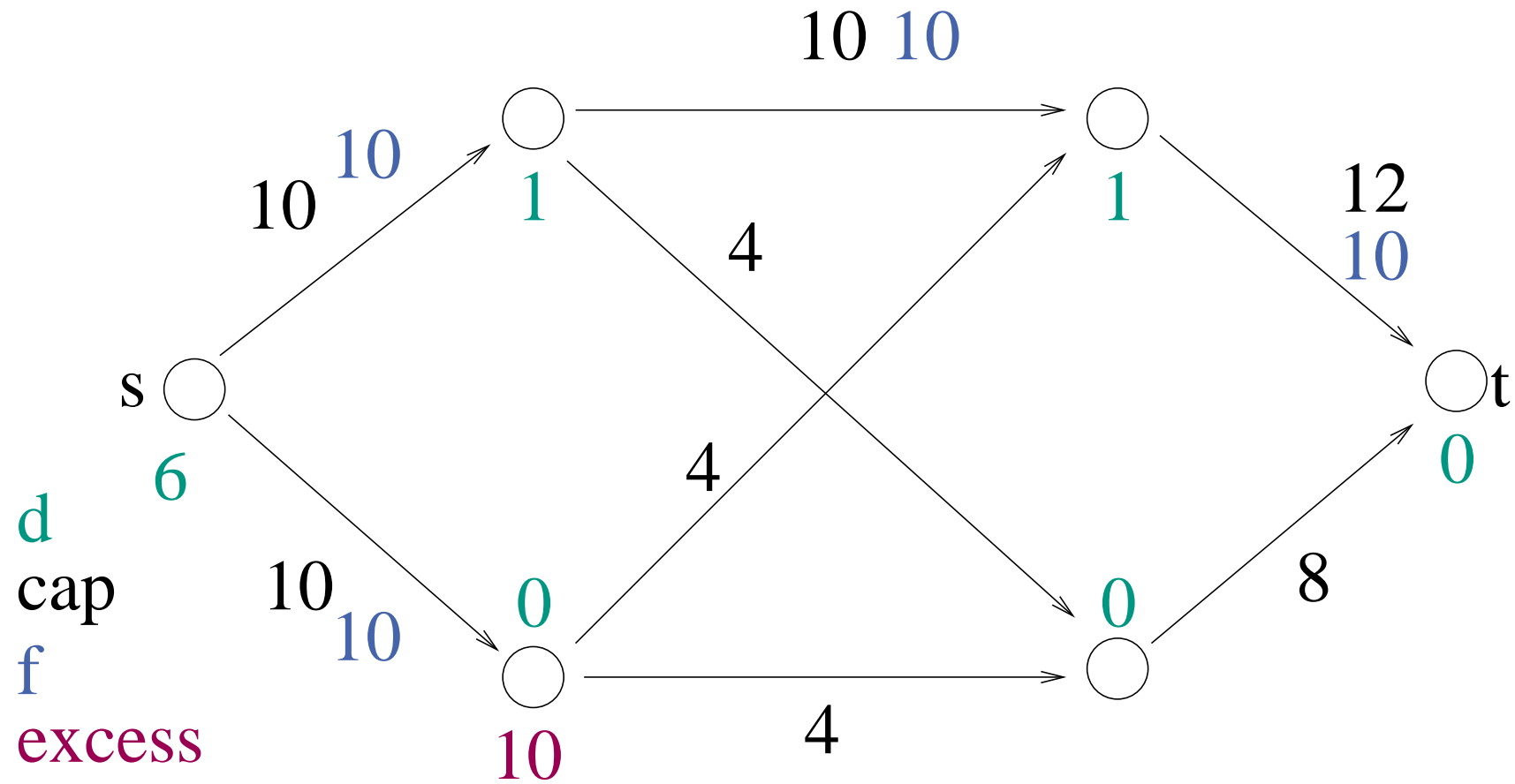

Example

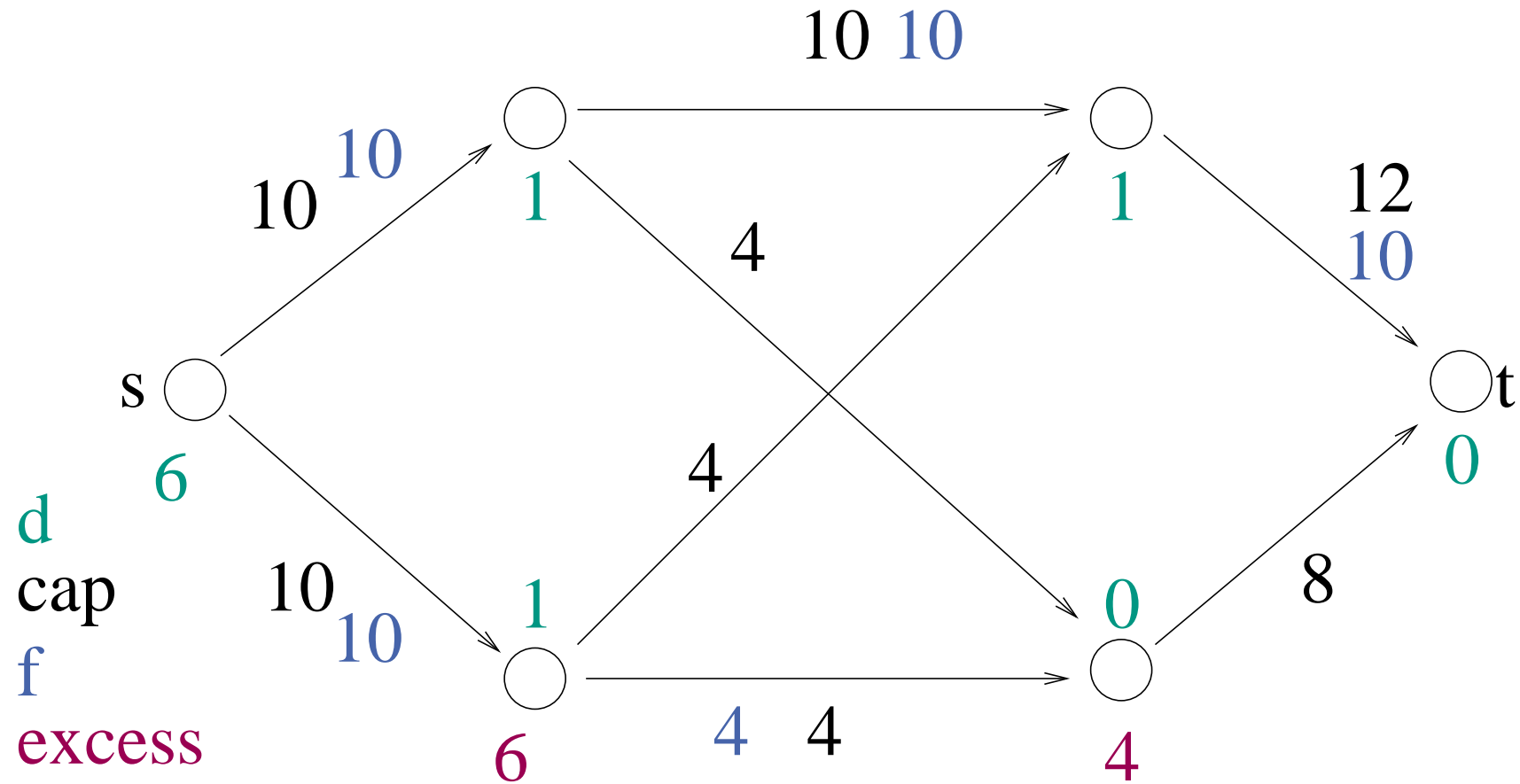

Example

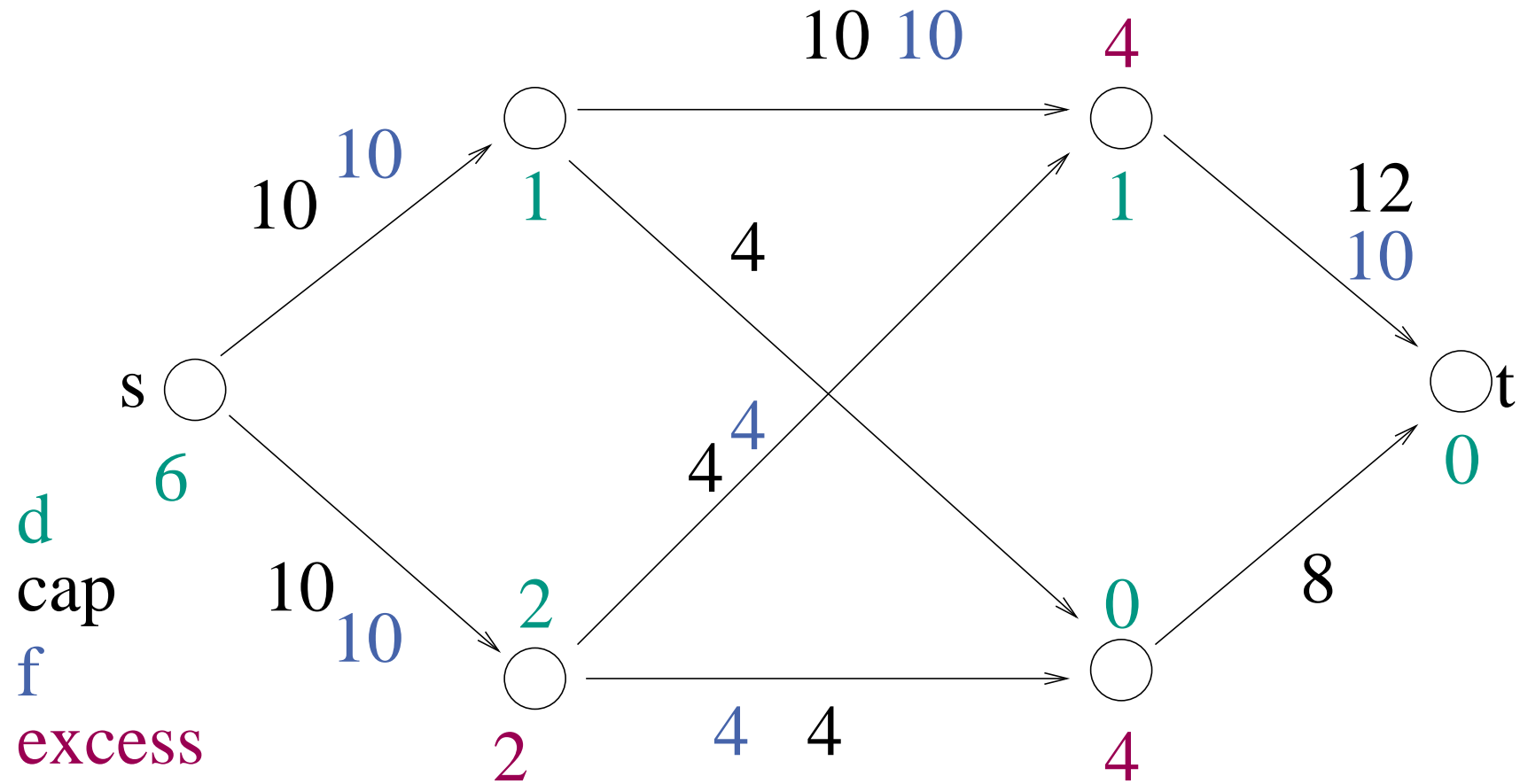

Example

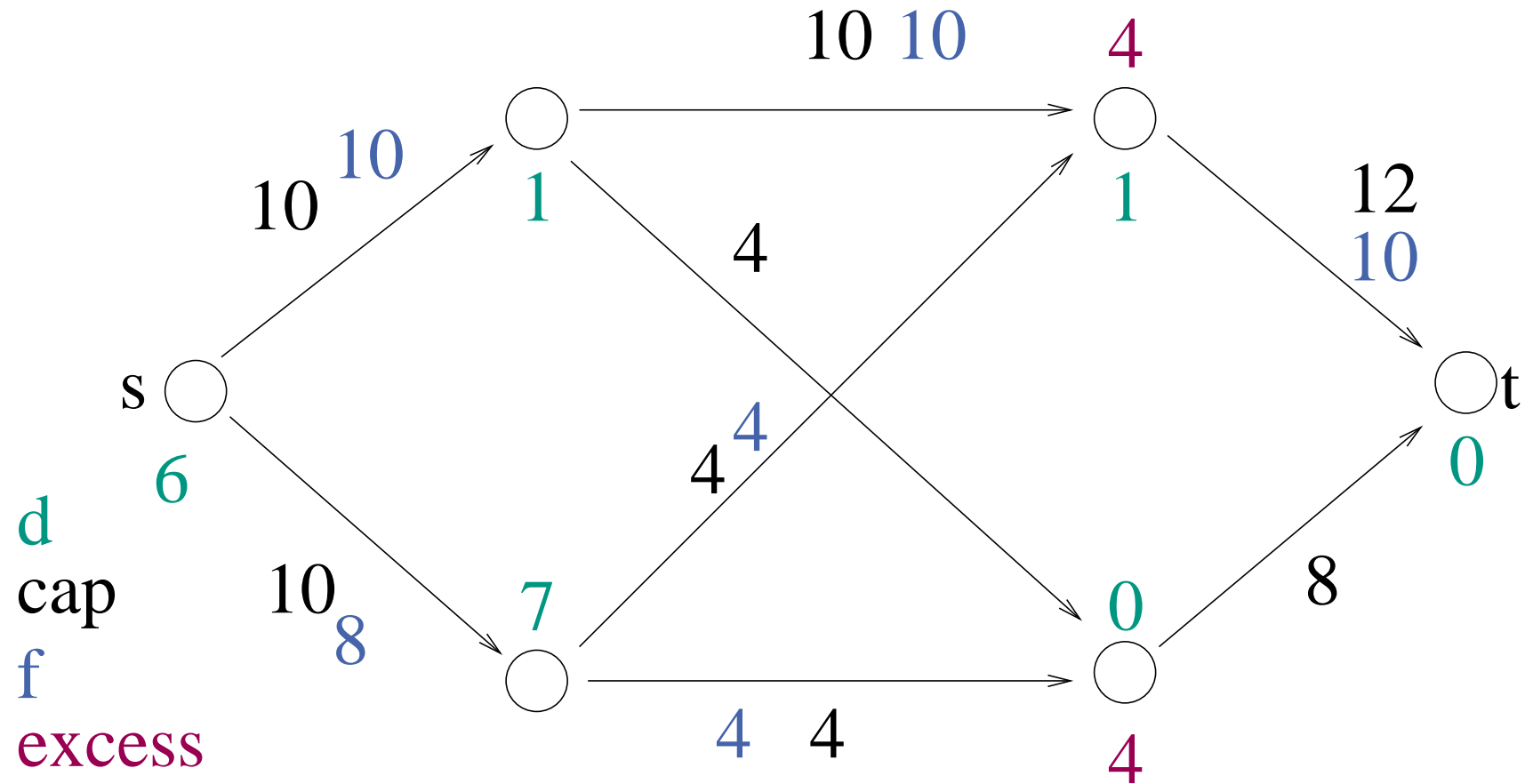

Example

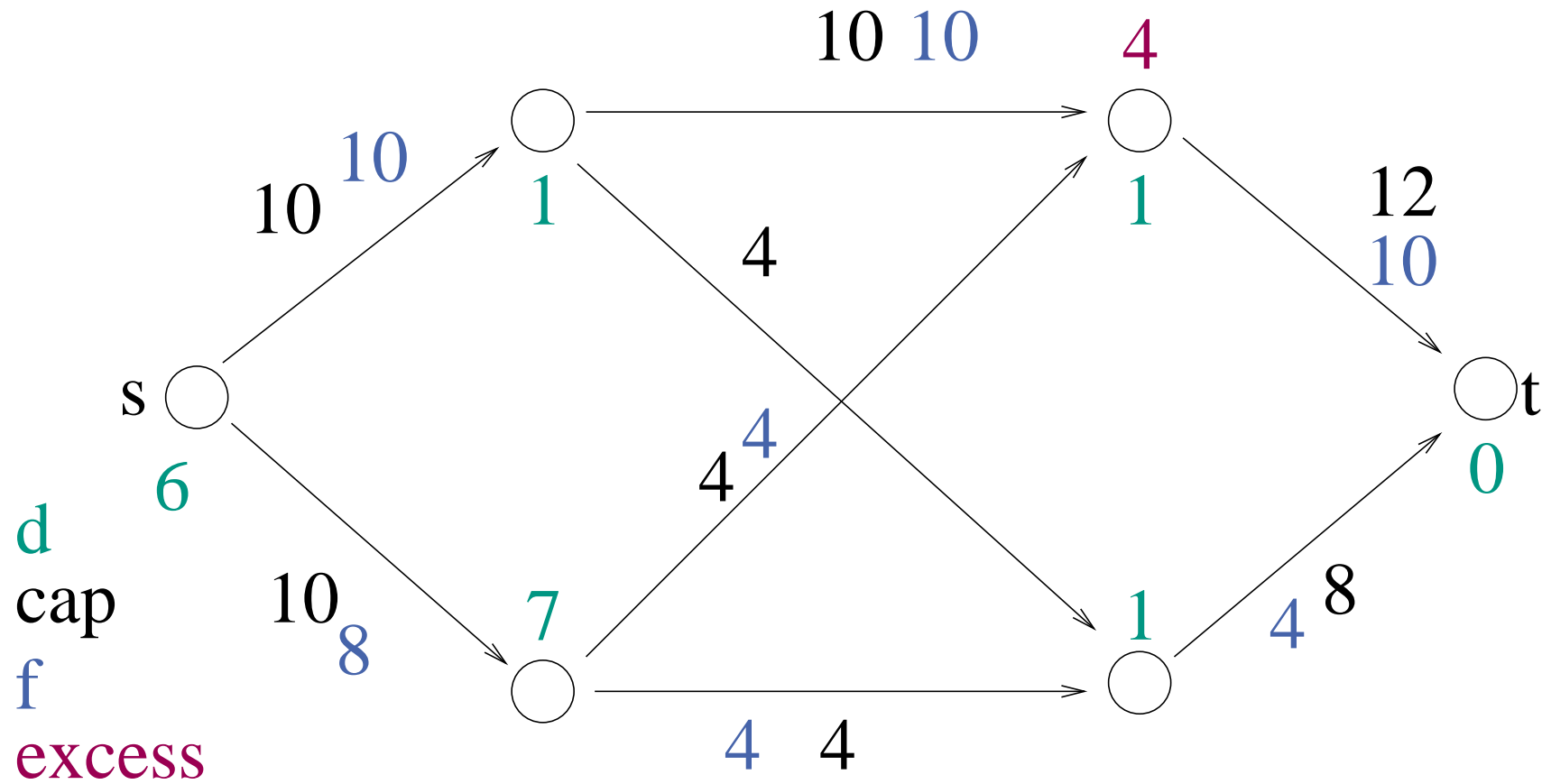

Example

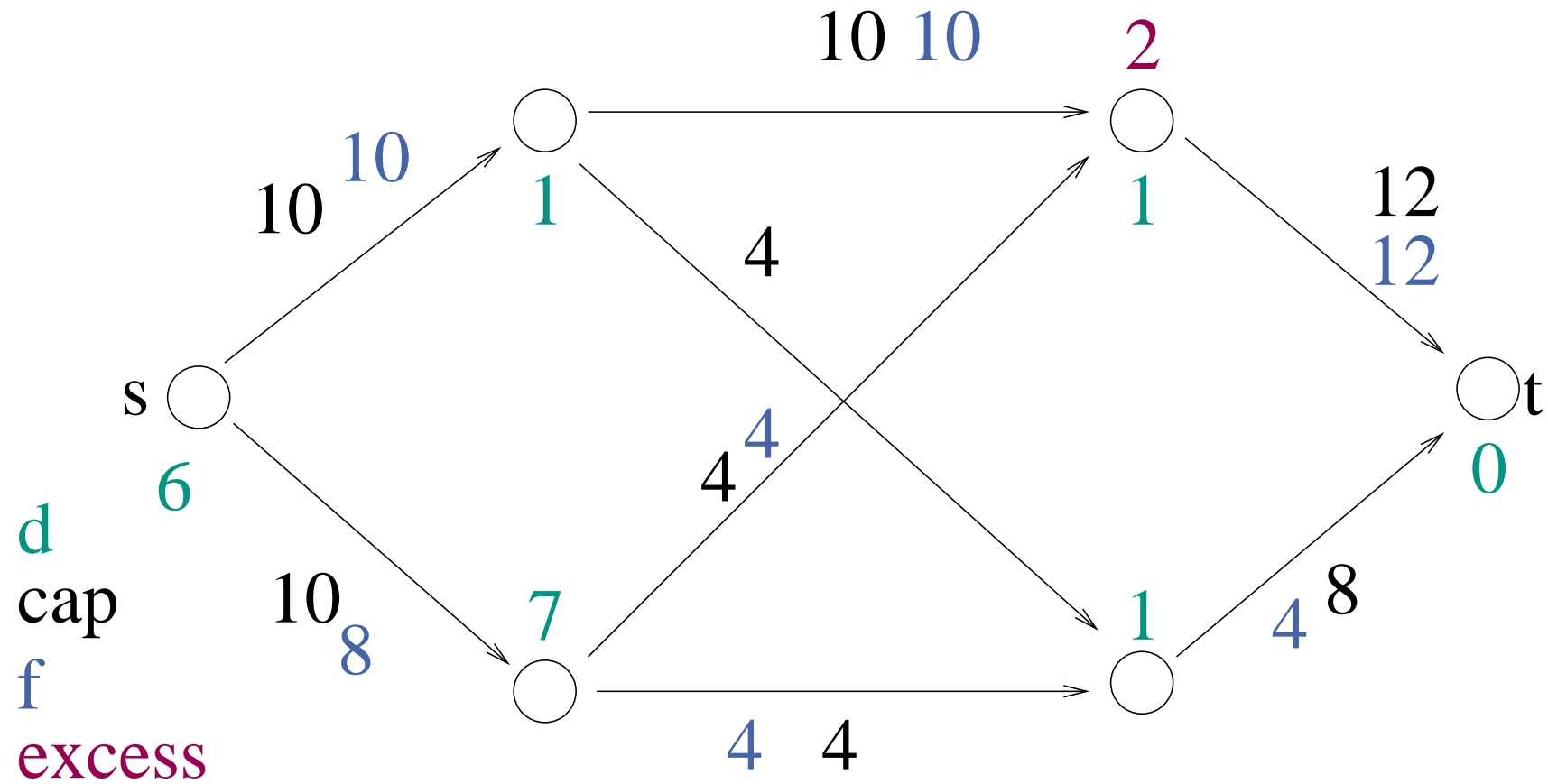

Example

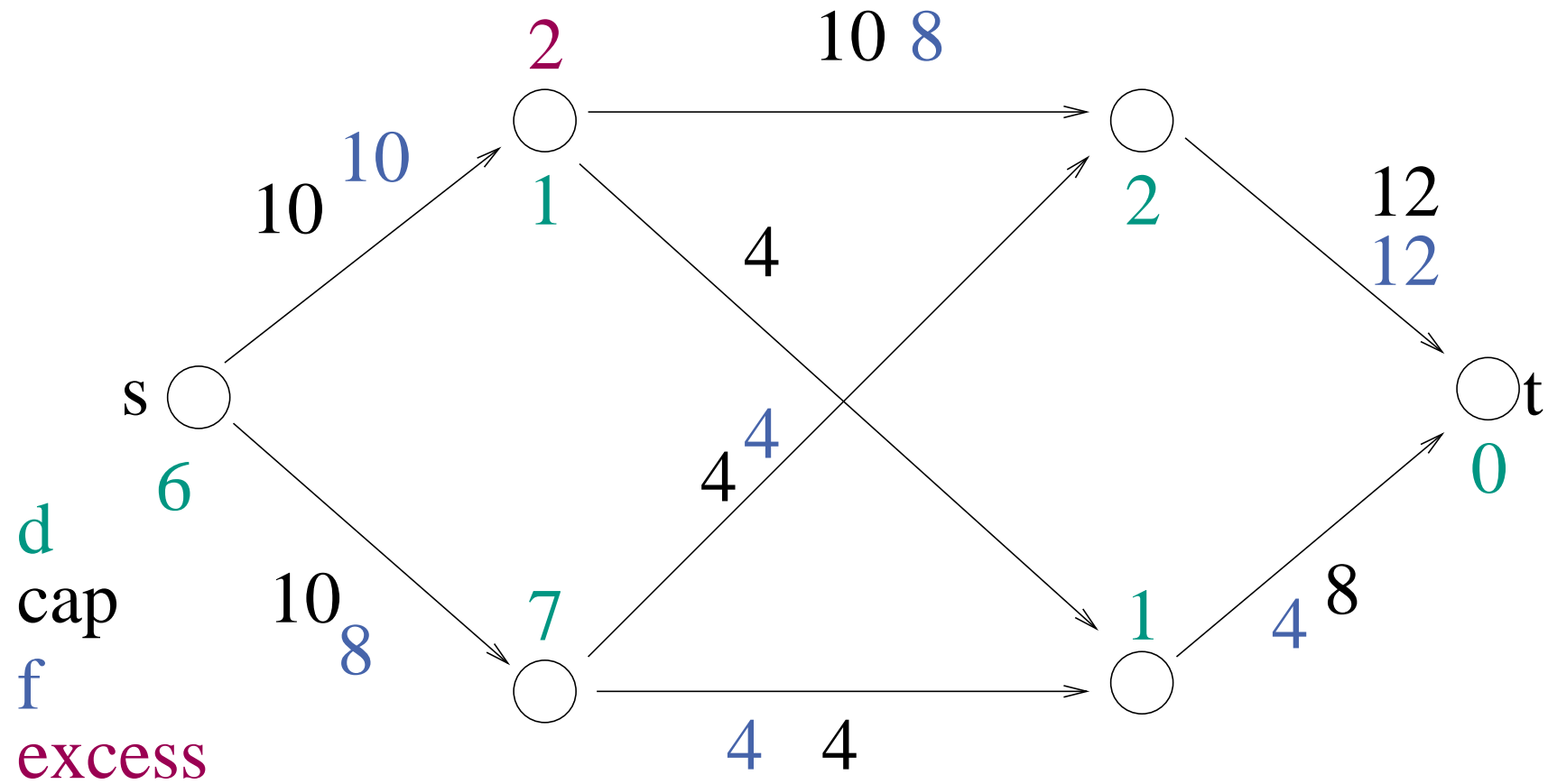

Example

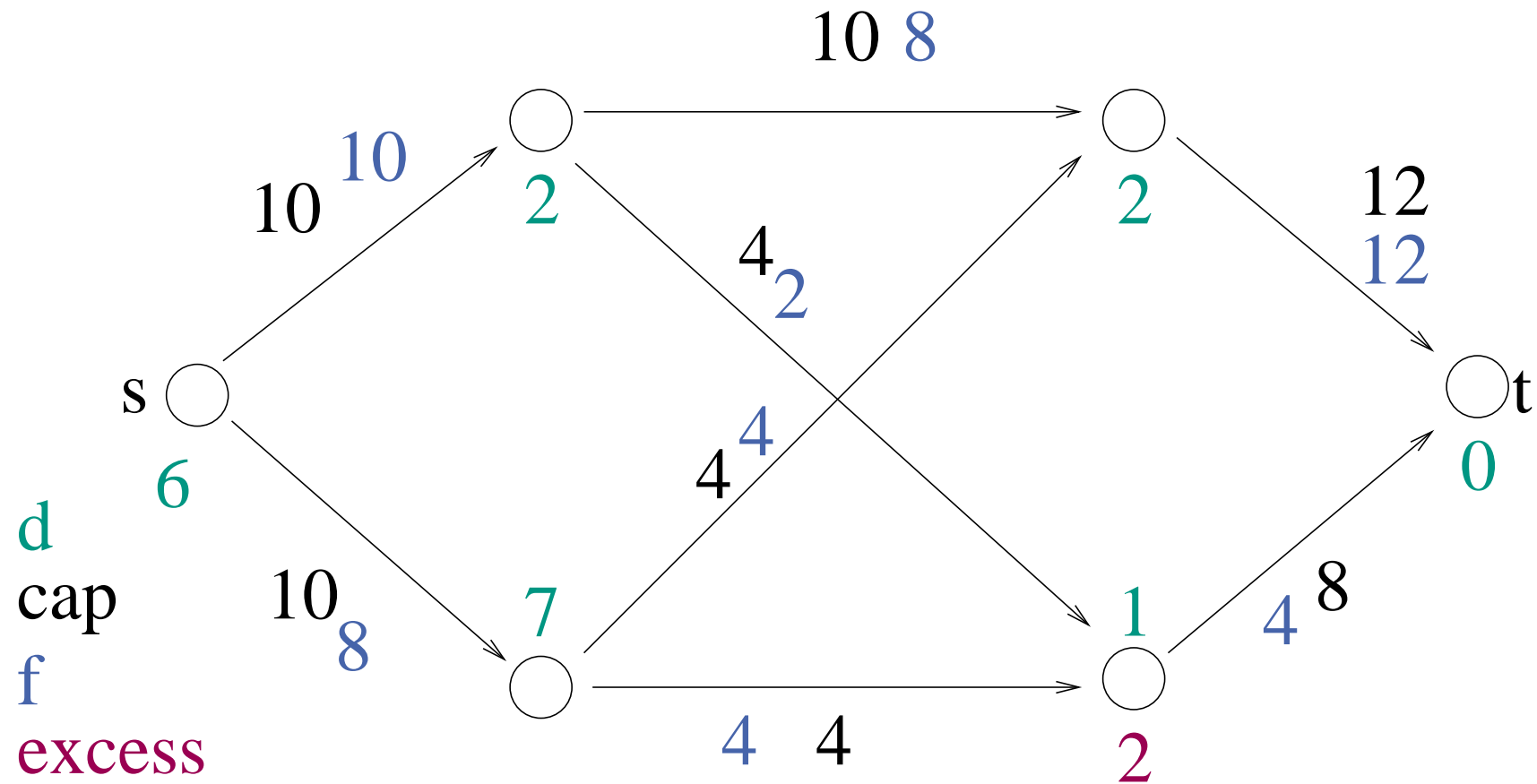

Example

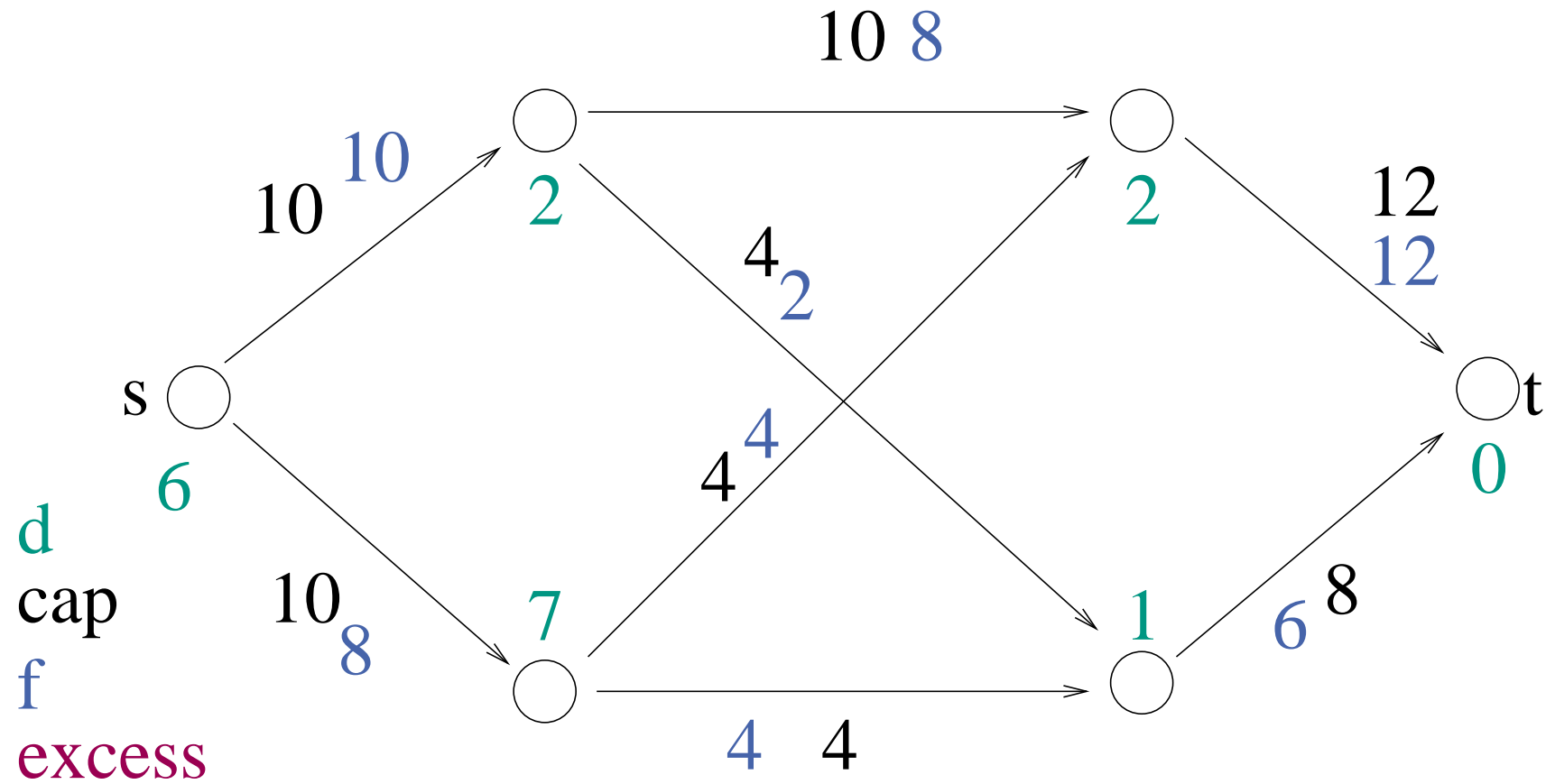

12 pushes in total

Partial Correctness

Lemma 3. *When genericPreflowPush terminates f is a maximal flow.*

Beweis.

f is a **flow** since $\forall v \in V \setminus \{s, t\} : \text{excess}(v) = 0$.

To show that f is **maximal**, it suffices to show that

\nexists path $p = \langle s, \dots, t \rangle \in G_f$ (Max-Flow Min-Cut Theorem):

Since $d(s) = n$, $d(t) = 0$, p would have to contain steep edges.

That would be a contradiction. □

Lemma 4. For any cut (S, T) ,

$$\sum_{u \in S} excess(u) = \sum_{e \in E \cap (T \times S)} f(e) - \sum_{e \in E \cap (S \times T)} f(e),$$

Proof:

$$\sum_{u \in S} excess(u) = \sum_{u \in S} \left(\sum_{(v, u) \in E} f((v, u)) - \sum_{(u, v) \in E} f((u, v)) \right)$$

Contributions of edge e to sum:

S to T : $-f(e)$

T to S : $f(e)$

within S : $f(e) - f(e) = 0$

within T : 0



Lemma 5.

\forall active nodes v : $\text{excess}(v) > 0 \Rightarrow \exists$ path $\langle v, \dots, s \rangle \in G_f$

Intuition: what got there can always go back.

Beweis. $S := \{u \in V : \exists \text{ path } \langle v, \dots, u \rangle \in G_f\}$, $T := V \setminus S$. Then

$$\sum_{u \in S} \text{excess}(u) = \sum_{e \in E \cap (T \times S)} f(e) - \sum_{e \in E \cap (S \times T)} f(e),$$

$\forall (u, w) \in E_f : u \in S \Rightarrow w \in S$ by Def. of G_f , S

$\Rightarrow \forall e = (u, w) \in E \cap (T \times S) : f(e) = 0$ Otherwise $(w, u) \in E_f$

Hence, $\sum_{u \in S} \text{excess}(u) \leq 0$

Only the negative excess of s can outweigh $\text{excess}(v) > 0$.

Hence $s \in S$. □

Lemma 6.

$$\forall v \in V : d(v) < 2n$$

Beweis.

Suppose v is lifted to $d(v) = 2n$.

By the Lemma 2, there is a (simple) path p to s in G_f .

p has at most $n - 1$ nodes

$$d(s) = n.$$

Hence $d(v) < 2n$. Contradiction (no steep edges).



Lemma 7. # Relabel operations $\leq 2n^2$

Beweis. $d(v) \leq 2n$, i.e., v is relabeled at most $2n$ times.

Hence, at most $|V| \cdot 2n = 2n^2$ relabel operations. □

Lemma 8. # saturating pushes $\leq nm$

Beweis.

We show that there are **at most n sat. pushes** over any edge $e = (v, w)$.

A saturating push(e, δ) **removes e** from E_f .

Only a **push on (w, v)** can **reinsert e** into E_f .

For this to happen, w must be **lifted** at least two levels.

Hence, at most $2n/2 = n$ saturating pushes over (v, w)

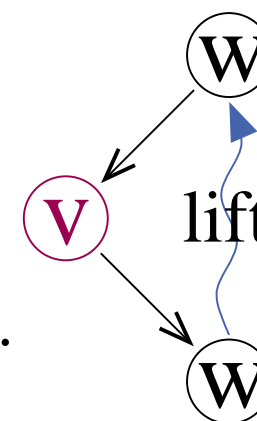

□

Lemma 9. # nonsaturating pushes = $O(n^2m)$

if $\delta = \min \left\{ \text{excess}(v), c_e^f \right\}$

for *arbitrary* node and edge selection rules.

(*arbitrary-preflow-push*)

Beweis. $\Phi := \sum_{\{v:v \text{ is active}\}} d(v).$ (Potential)

$\Phi = 0$ initially **and** at the end (no active nodes left!)

Operation	$\Delta(\Phi)$	How many times?	Total effect
relabel	1	$\leq 2n^2$	$\leq 2n^2$
saturating push	$\leq 2n$	$\leq nm$	$\leq 2n^2m$
nonsaturating push	≤ -1		

$\Phi \geq 0$ always.



Searching for Eligible Edges

Every node v maintains a **currentEdge** pointer to its sequence of outgoing edges in G_f .

invariant no edge $e = (v, w)$ to the left of currentEdge is eligible

Reset currentEdge at a relabel ($\leq 2n \times$)

Invariant cannot be violated by a push over a reverse edge $e' = (w, v)$

since this only happens when e' is downward,

i.e., e is upward and hence not eligible.

Lemma 10.

Total cost for searching $\leq \sum_{v \in V} 2n \cdot \text{degree}(v) = 4nm = \mathbf{O}(nm)$

Satz 11. *Arbitrary Preflow Push finds a maximum flow in time $O(n^2m)$.*

Beweis.

Lemma 3: partial correctness

Initialization in time $O(n + m)$.

Maintain set (e.g., stack, FIFO) of active nodes.

Use reverse edge pointers to implement push.

Lemma 7: $2n^2$ relabel operations

Lemma 8: nm saturating pushes

Lemma 9: $O(n^2m)$ nonsaturating pushes

Lemma 10: $O(nm)$ search time for eligible edges

Total time $O(n^2m)$



FIFO Preflow push

Examine a node: Saturating pushes until nonsaturating push or relabel.

Examine all nodes in phases (or use FIFO queue).

Theorem: time $O(n^3)$

Proof: not here

Highest Level Preflow Push

Always select active nodes that **maximize** $d(v)$

Use **bucket priority queue** (insert, increaseKey, deleteMax)

not monotone (!) but **relabels** “pay” for scan operations

Lemma 12. *At most $n^2\sqrt{m}$ nonsaturating pushes.*

Beweis. later



Satz 13. *Highest Level Preflow Push finds a maximum flow in time $O(n^2\sqrt{m})$.*

Example

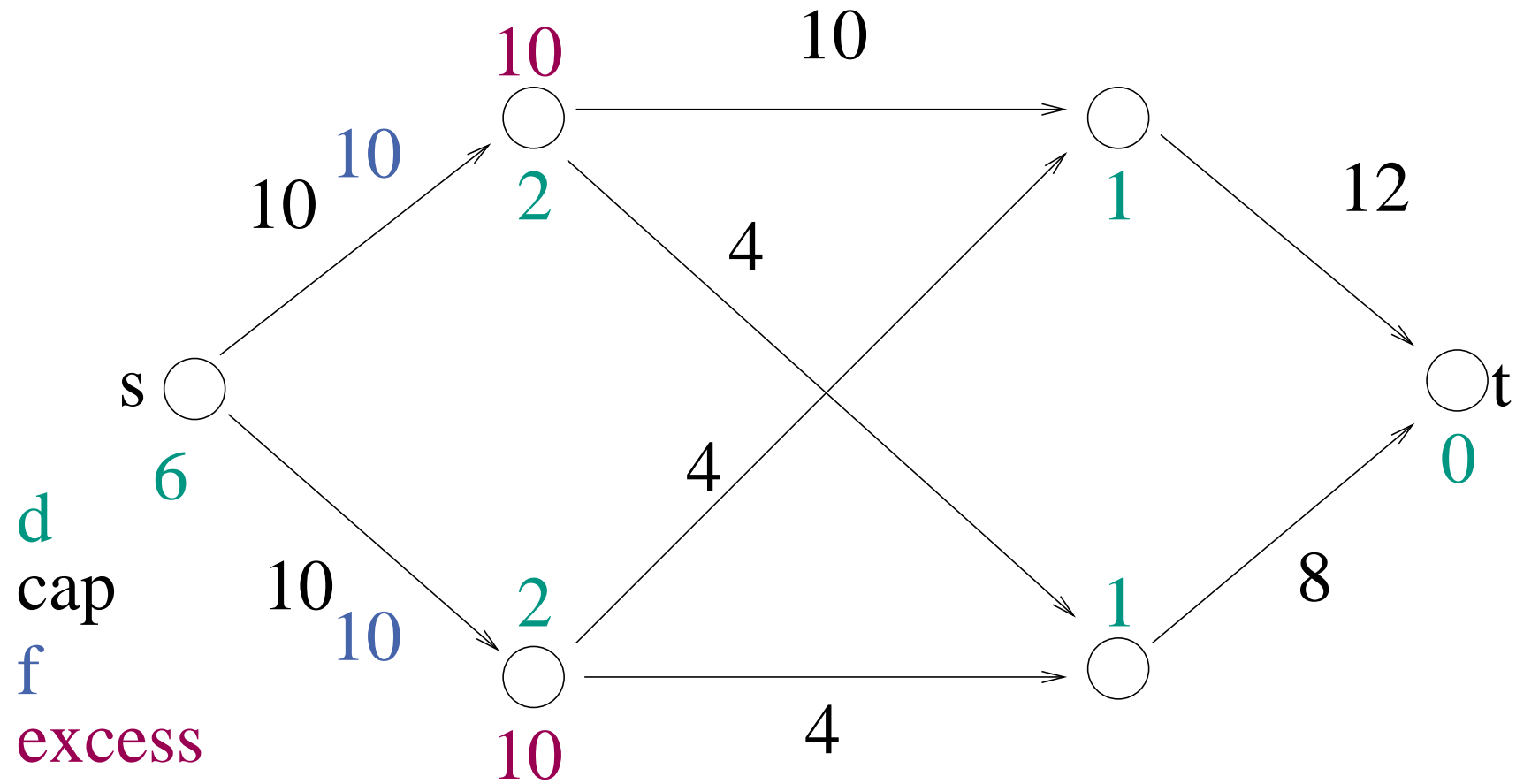

Example

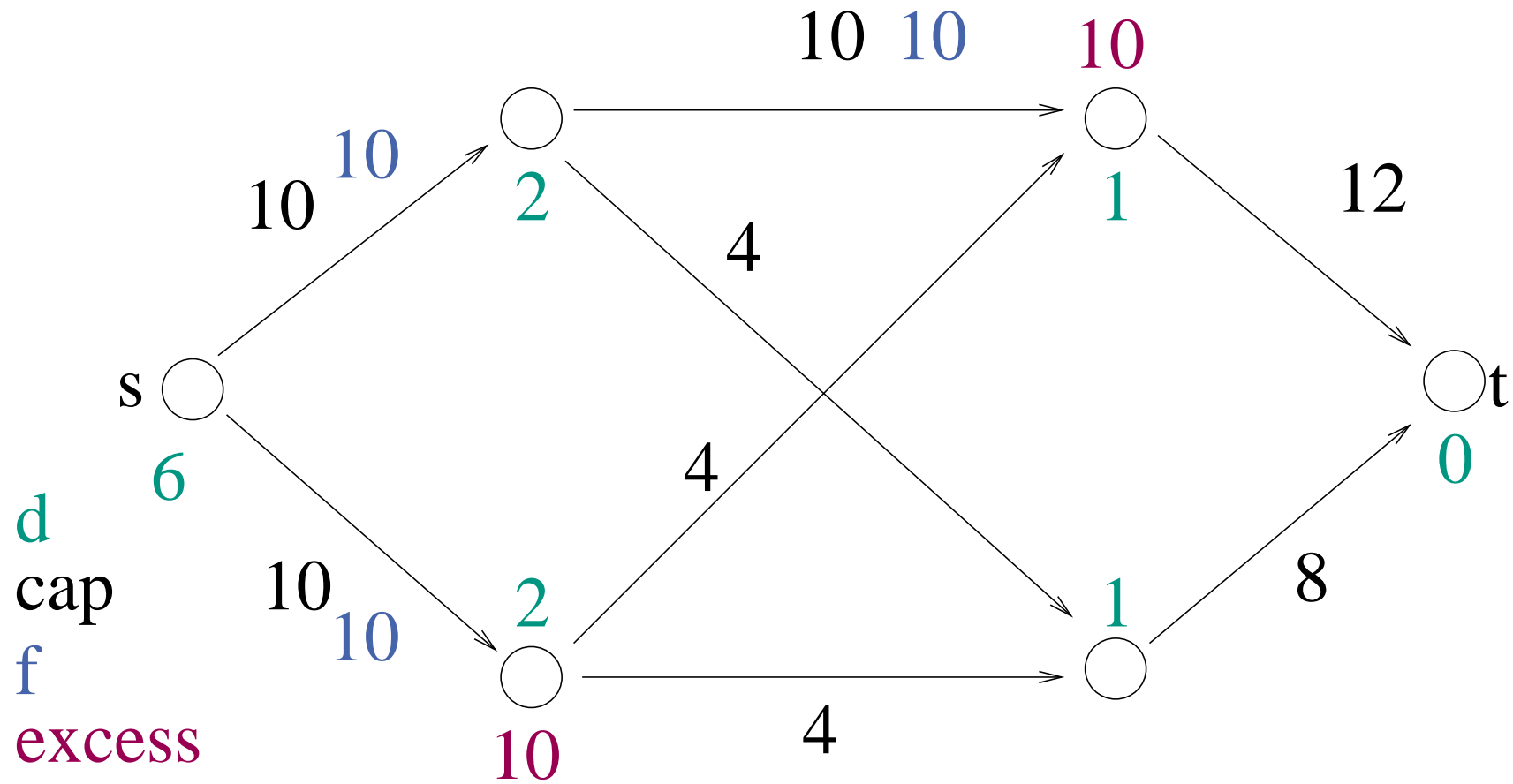

Example

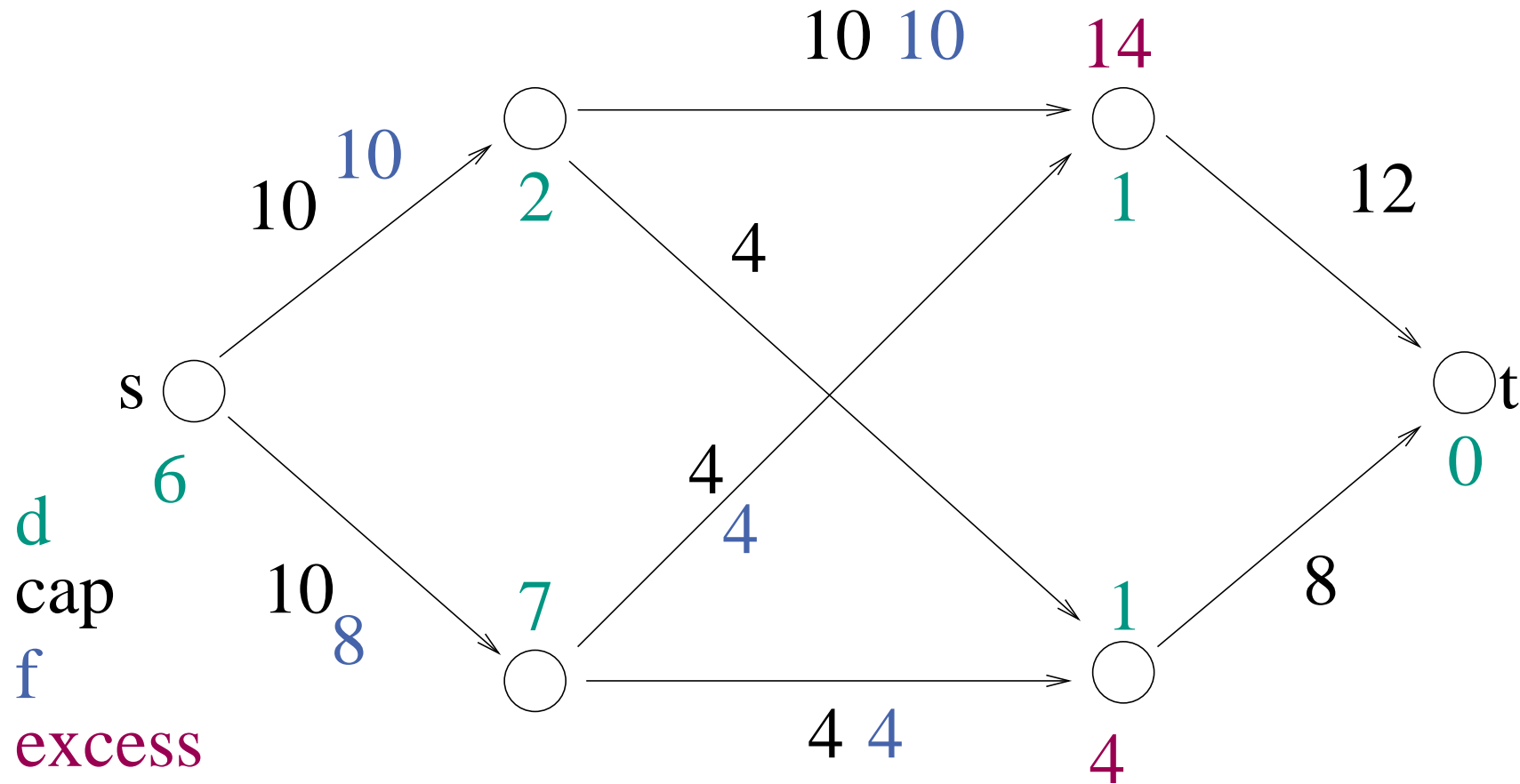

Example

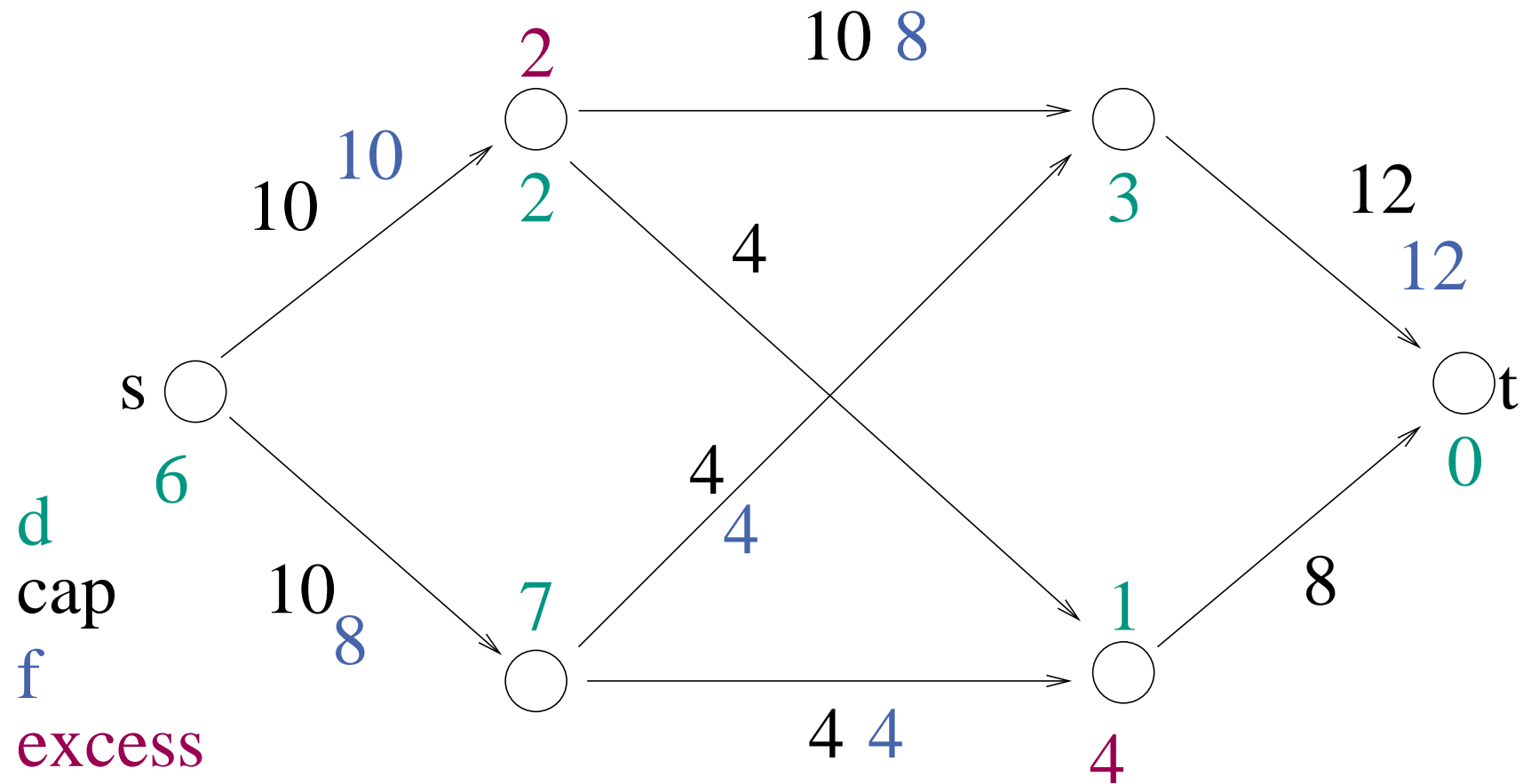

Example

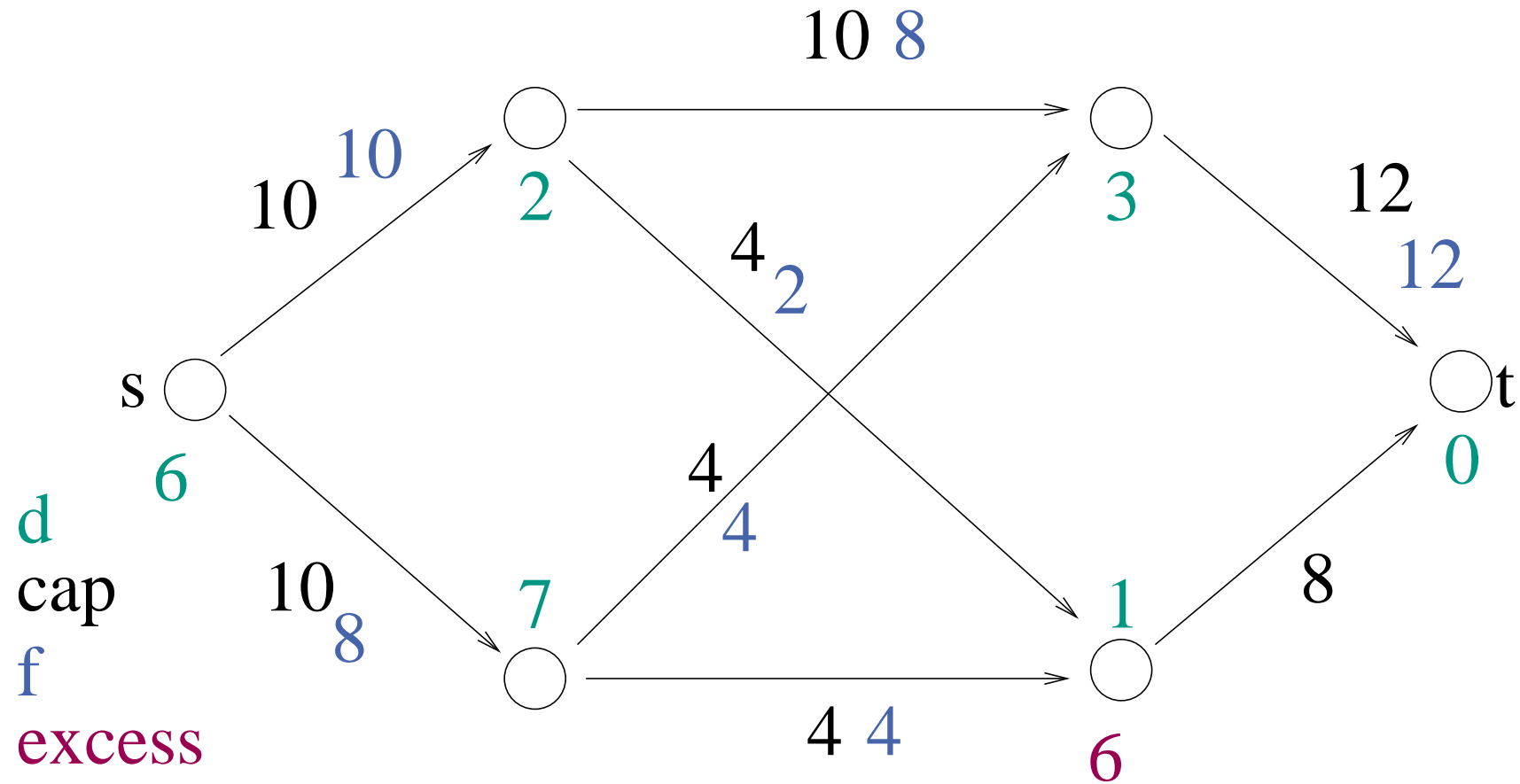

Example

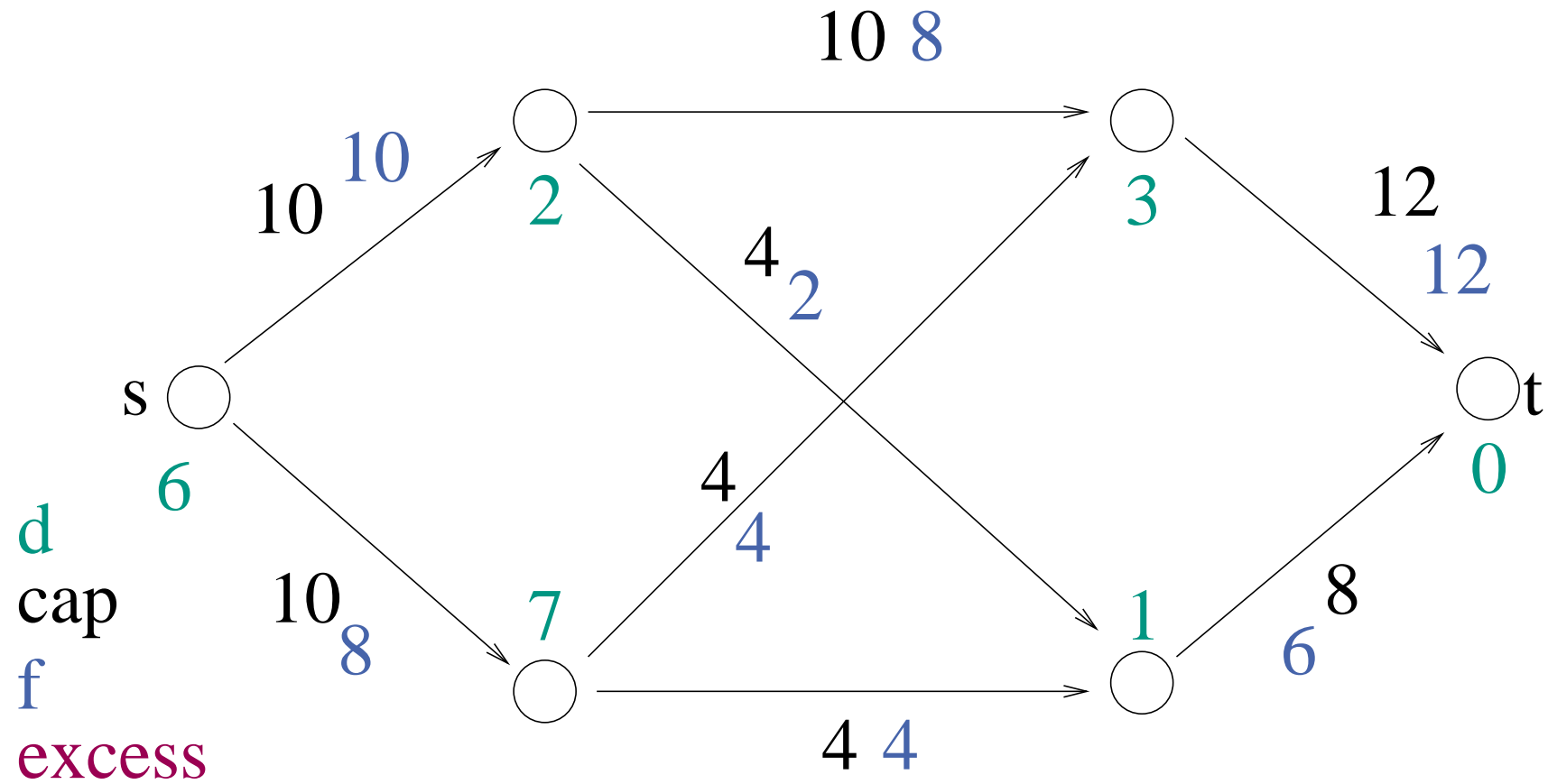

9 pushes in total, 3 less than before

Proof of Lemma 12

$K := \sqrt{m}$ tuning parameter

$d'(v) := \frac{|\{w : d(w) \leq d(v)\}|}{K}$ scaled number of dominated nodes

$\Phi := \sum_{\{v:v \text{ is active}\}} d'(v).$ (Potential)

$d^* := \max \{d(v) : v \text{ is active}\}$ (highest level)

phase:= all pushes between two consecutive changes of d^*

expensive phase: more than K pushes

cheap phase: otherwise

Claims:

1. $\leq 4n^2K$ nonsaturating pushes in all cheap phases together
2. $\Phi \geq 0$ always, $\Phi \leq n^2/K$ initially (obvious)
3. a relabel or saturating push increases Φ by at most n/K .
4. a nonsaturating push does not increase Φ .
5. an expensive phase with $Q \geq K$ nonsaturating pushes decreases Φ by at least Q .

Operation	Amount
Relabel	$2n^2$
Sat.push	nm

Lemma 7 + Lemma 8 + 2. + 3. + 4. \Rightarrow

total possible decrease $\leq (2n^2 + nm) \frac{n}{K} + \frac{n^2}{K}$

This + 5. $\leq \frac{2n^3 + n^2 + mn^2}{K}$ nonsaturating pushes in expensive phases

This + 1. $\leq \frac{2n^3 + n^2 + mn^2}{K} + 4n^2K = O(n^2 \sqrt{m})$ nonsaturating

pushes overall for $K = \sqrt{m}$



Claims:

1. $\leq 4n^2 K$ nonsaturating pushes in all cheap phases together

We first show that there are at most $4n^2$ phases

(changes of $d^* = \max \{d(v) : v \text{ is active}\}$).

$d^* = 0$ initially, $d^* \geq 0$ always.

Only **relabel** operations increase d^* , i.e.,

$\leq 2n^2$ increases by **Lemma 7** and hence

$\leq 2n^2$ decreases

$\leq 4n^2$ changes overall

By definition of a cheap phase, it has at most K pushes.

Claims:

1. $\leq 4n^2K$ nonsaturating pushes in all cheap phases together
2. $\Phi \geq 0$ always, $\Phi \leq n^2/K$ initially (obvious)
3. a relabel or saturating push increases Φ by at most n/K .

Let v denote the relabeled or activated node.

$$d'(v) := \frac{|\{w : d(w) \leq d(v)\}|}{K} \leq \frac{n}{K}$$

A relabel of v can increase only the d' -value of v .

A saturating push on (u, w) may activate only w .

Claims:

1. $\leq 4n^2K$ nonsaturating pushes in all cheap phases together
2. $\Phi \geq 0$ always, $\Phi \leq n^2/K$ initially (obvious)
3. a relabel or saturating push increases Φ by at most n/K .
4. a nonsaturating push does not increase Φ .

v is deactivated ($\text{excess}(v)$ is now 0)

w may be activated

but $d'(w) \leq d'(v)$ (we do not push flow away from the sink)

Claims:

1. $\leq 4n^2K$ nonsaturating pushes in all cheap phases together
2. $\Phi \geq 0$ always, $\Phi \leq n^2/K$ initially (obvious)
3. a relabel or saturating push increases Φ by at most n/K .
4. a nonsaturating push does not increase Φ .
5. an expensive phase with $Q \geq K$ nonsaturating pushes decreases Φ by at least Q .

During a phase d^* remains constant

Each nonsat. push decreases the number of active nodes at level d^*

Hence, $|\{w : d(w) = d^*\}| \geq Q \geq K$ during an expensive phase

Each nonsat. push across (v, w) decreases Φ by

$$\geq d'(v) - d'(w) \geq |\{w : d(w) = d^*\}| / K \geq K / K = 1$$



Claims:

1. $\leq 4n^2K$ nonsaturating pushes in all cheap phases together
2. $\Phi \geq 0$ always, $\Phi \leq n^2/K$ initially (obvious)
3. a relabel or saturating push increases Φ by at most n/K .
4. a nonsaturating push does not increase Φ .
5. an expensive phase with $Q \geq K$ nonsaturating pushes decreases Φ by at least Q .

Operation	Amount
Relabel	$2n^2$
Sat.push	nm

Lemma 7 + Lemma 8 + 2. + 3. + 4. \Rightarrow

total possible decrease $\leq (2n^2 + nm) \frac{n}{K} + \frac{n^2}{K}$

This + 5. $\leq \frac{2n^3 + n^2 + mn^2}{K}$ nonsaturating pushes in expensive phases

This + 1. $\leq \frac{2n^3 + n^2 + mn^2}{K} + 4n^2K = O(n^2 \sqrt{m})$ nonsaturating

pushes overall for $K = \sqrt{m}$



MFIFO: Modified FIFO Selection Rule

pushFront after relabel.

pushBack when activated by a push N

Heuristic Improvements

Naive algorithm has needs $\Omega(n^2)$ even on a path graph. We can do better.

aggressive local relabeling:

$$d(v) := 1 + \min \{ d(w) : (v, w) \in G_f \}$$

(like a sequence of relabels)

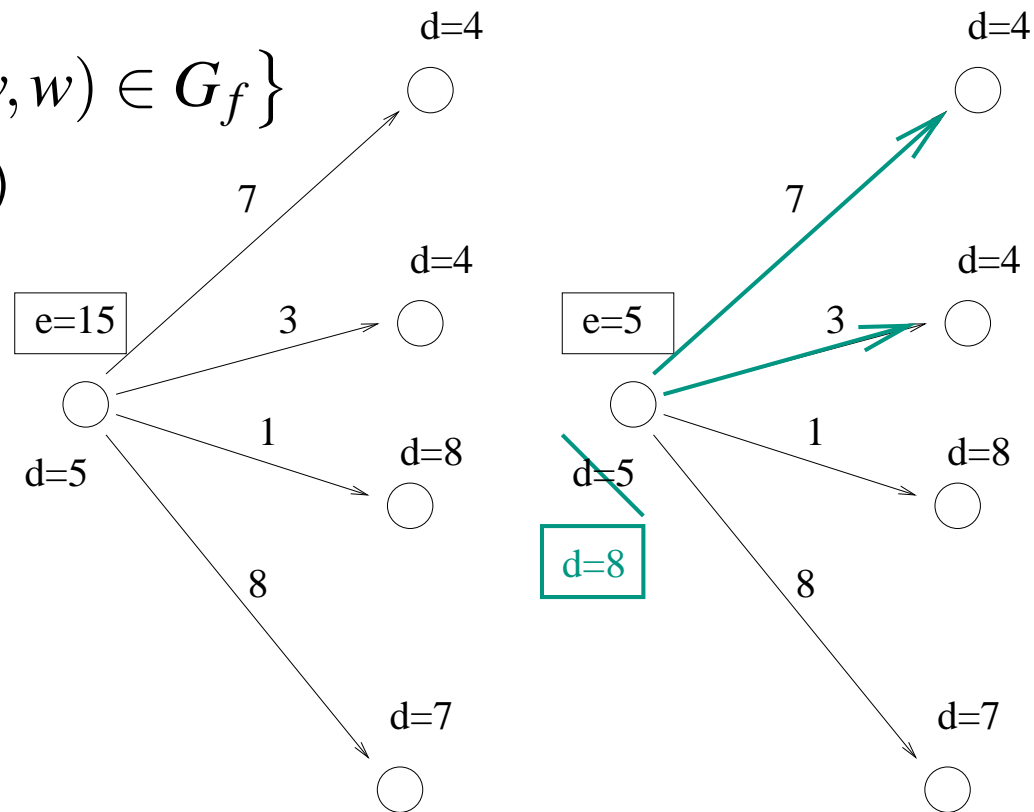

Heuristic Improvements

Naive algorithm has **best case** $\Omega(n^2)$. Why? We can do better.

aggressive local relabeling: $d(v) := 1 + \min \{d(w) : (v, w) \in G_f\}$

(like a sequence of relabels)

global relabeling: (initially and every $O(m)$ edge inspections):

$d(v) := G_f.\text{reverseBFS}(t)$ for nodes that can reach t in G_f .

Special treatment of nodes with $d(v) \geq n$. (**Returning flow** is easy)

Gap Heuristics. No node can connect to t across an empty level:

if $\{v : d(v) = i\} = \emptyset$ **then foreach** v with $d(v) > i$ **do** $d(v) := n$

Experimental results

We use four classes of graphs:

- Random: n nodes, $2n + m$ edges; all edges (s, v) and (v, t) exist
- Cherkassky and Goldberg (1997) (two graph classes)
- Ahuja, Magnanti, Orlin (1993)

Timings: Random Graphs

Rule	BASIC	Ln	LRH	GRH	GAP	LEDA
FF	5.84	6.02	4.75	0.07	0.07	—
	33.32	33.88	26.63	0.16	0.17	—
HL	6.12	6.3	4.97	0.41	0.11	0.07
	27.03	27.61	22.22	1.14	0.22	0.16
MF	5.36	5.51	4.57	0.06	0.07	—
	26.35	27.16	23.65	0.19	0.16	—

$n \in \{1000, 2000\}, m = 3n$

FF=FIFO node selection, HL=highest level, MF=modified FIFO

Ln = $d(v) \geq n$ is special,

LRH=local relabeling heuristic, GRH=global relabeling heuristics

Timings: CG1

Rule	BASIC	Ln	LRH	GRH	GAP	LEDA
FF	3.46	3.62	2.87	0.9	1.01	—
	15.44	16.08	12.63	3.64	4.07	—
HL	20.43	20.61	20.51	1.19	1.33	0.8
	192.8	191.5	193.7	4.87	5.34	3.28
MF	3.01	3.16	2.3	0.89	1.01	—
	12.22	12.91	9.52	3.65	4.12	—

$n \in \{1000, 2000\}, m = 3n$

FF=FIFO node selection, HL=highest level, MF=modified FIFO

Ln = $d(v) \geq n$ is special,

LRH=local relabeling heuristic, GRH=global relabeling heuristics

Timings: CG2

Rule	BASIC	Ln	LRH	GRH	GAP	LEDA
FF	50.06	47.12	37.58	1.76	1.96	—
	239	222.4	177.1	7.18	8	—
HL	42.95	41.5	30.1	0.17	0.14	0.08
	173.9	167.9	120.5	0.36	0.28	0.18
MF	45.34	42.73	37.6	0.94	1.07	—
	198.2	186.8	165.7	4.11	4.55	—

$n \in \{1000, 2000\}, m = 3n$

FF=FIFO node selection, HL=highest level, MF=modified FIFO

Ln = $d(v) \geq n$ is special,

LRH=local relabeling heuristic, GRH=global relabeling heuristics

Timings: AMO

Rule	BASIC	Ln	LRH	GRH	GAP	LEDA
FF	12.61	13.25	1.17	0.06	0.06	—
	55.74	58.31	5.01	0.1399	0.1301	—
HL	15.14	15.8	1.49	0.13	0.13	0.07
	62.15	65.3	6.99	0.26	0.26	0.14
MF	10.97	11.65	0.04999	0.06	0.06	—
	46.74	49.48	0.1099	0.1301	0.1399	—

$n \in \{1000, 2000\}, m = 3n$

FF=FIFO node selection, HL=highest level, MF=modified FIFO

Ln = $d(v) \geq n$ is special,

LRH=local relabeling heuristic, GRH=global relabeling heuristics

Asymptotics, $n \in \{5000, 10000, 20000\}$

Gen	Rule	GRH			GAP			LEDA		
rand	FF	0.16	0.41	1.16	0.15	0.42	1.05	—	—	—
	HL	1.47	4.67	18.81	0.23	0.57	1.38	0.16	0.45	1.09
	MF	0.17	0.36	1.06	0.14	0.37	0.92	—	—	—
CG1	FF	3.6	16.06	69.3	3.62	16.97	71.29	—	—	—
	HL	4.27	20.4	77.5	4.6	20.54	80.99	2.64	12.13	48.52
	MF	3.55	15.97	68.45	3.66	16.5	70.23	—	—	—
CG2	FF	6.8	29.12	125.3	7.04	29.5	127.6	—	—	—
	HL	0.33	0.65	1.36	0.26	0.52	1.05	0.15	0.3	0.63
	MF	3.86	15.96	68.42	3.9	16.14	70.07	—	—	—
AMO	FF	0.12	0.22	0.48	0.11	0.24	0.49	—	—	—
	HL	0.25	0.48	0.99	0.24	0.48	0.99	0.12	0.24	0.52
	MF	0.11	0.24	0.5	0.11	0.24	0.48	—	—	—

Recent AE Results on Max-Flow

Faster and More Dynamic Maximum Flow by Incremental Breadth-First Search, Goldberg, Hed, Kaplan, Kohli, Tarjan, Werneck, ESA 2015

- Much **faster** on many (relatively easy) **real world** instances (image processing, graph partitioning, . . .) than preflow-push
- Worst case performance guarantee $O(mn^2)$ (as in Dinitz algorithm)
- Adaptable to **dynamic** scenarios
- Uses **pseudoflows** that allow excesses and **deficits**.

Open problem: close gaps between theory and practice!

Zusammenfassung Flows und Matchings

- Natürliche Verallgemeinerung von kürzesten Wegen:
ein Pfad \rightsquigarrow viele Pfade
- viele Anwendungen
- “schwierigste/allgemeinste” Graph-Probleme, die sich mit
kombinatorischen Algorithmen in **Polynomialzeit** lösen lassen
- Beispiel für nichttriviale Algorithmenanalyse
- Potentialmethode** (\neq **Knoten**potentiale)
- Algorithm Engineering: practical case \neq worst case.
Heuristiken/Details/Eingabeeigenschaften wichtig
- Datenstrukturen: bucket queues, graph representation, (dynamic trees)