

Text Indexing

Lecture 10: Top- k Document Retrieval

Florian Kurpicz

The slides are licensed under a Creative Commons Attribution-ShareAlike 4.0 International License © ⓘ ⓘ: www.creativecommons.org/licenses/by-sa/4.0 | commit 59da60d compiled at 2025-01-13-12:54



<https://pingo.scc.kit.edu/815630>

Document Listing

- similar to document retrieval
- get all documents containing a *phrase*

Definition: Document Listing

Given a collection of D documents $\mathcal{D} = \{d_1, d_2, \dots, d_D\}$ containing symbols from an alphabet $\Sigma = [1, \sigma]$ and a pattern $P \in \Sigma^*$, return all $j \in [1, D]$, such that d_j contains P .

Document Listing

- similar to document retrieval
- get all documents containing a *phrase*

Definition: Document Listing

Given a collection of D documents $\mathcal{D} = \{d_1, d_2, \dots, d_D\}$ containing symbols from an alphabet $\Sigma = [1, \sigma]$ and a pattern $P \in \Sigma^*$, return all $j \in [1, D]$, such that d_j contains P .

- $d_1 = \text{ATA}$
- $d_2 = \text{TAAA}$
- $d_3 = \text{TATA}$

And for queries:

- $P = \text{TA}$ is contained in d_1, d_2 , and d_3
- $P = \text{ATA}$ is contained in d_1 and d_3

Basic Concepts

Definition: Document Concatenation

Given a collection of D documents $\mathcal{D} = \{d_1, d_2, \dots, d_D\}$ containing symbols from an alphabet $\Sigma = [1, \sigma]$ where each document **ends with a special symbol** $\# \notin \Sigma$, the string

$$\mathcal{C} = d_1 d_2 \dots d_D \$$$

is called the concatenation of the documents with $\$ \notin \Sigma$ and $\$ < \# < \alpha$ for all $\alpha \in \Sigma$

- $N = |\mathcal{C}| = \sum_{i=1}^D |d_i|$

Basic Concepts

Definition: Document Concatenation

Given a collection of D documents $\mathcal{D} = \{d_1, d_2, \dots, d_D\}$ containing symbols from an alphabet $\Sigma = [1, \sigma]$ where each document **ends with a special symbol** $\# \notin \Sigma$, the string

$$\mathcal{C} = d_1 d_2 \dots d_D \$$$

is called the concatenation of the documents with $\$ \notin \Sigma$ and $\$ < \# < \alpha$ for all $\alpha \in \Sigma$

- $N = |\mathcal{C}| = \sum_{i=1}^D |d_i|$

- $d_1 = \text{ATA}$
- $d_2 = \text{TAAA}$
- $d_3 = \text{TATA}$

Document Concatenation:

- $\text{ATA}\#\text{TAAA}\#\text{TATA}\#\text{\$}$

Suffix Array for Document Concatenation

- given a document concatenation \mathcal{C} , build the suffix array
- requires $O(n)$ time
- entries in suffix array correspond to documents

Suffix Array for Document Concatenation

- given a document concatenation \mathcal{C} , build the suffix array
- requires $O(n)$ time
- entries in suffix array correspond to documents

Definition: Document Array

Given a document concatenation \mathcal{C} and its suffix array SA , the **document array** DA is defined as

$$DA[i] = j \iff \sum_{k=1}^{j-1} |d_k| < SA[i] \leq \sum_{k=1}^j |d_k|$$

for $i > 1$ and $DA[1] = 0$

Suffix Array for Document Concatenation

- given a document concatenation \mathcal{C} , build the **suffix array**
- requires $O(n)$ time
- entries in suffix array correspond to documents

	1	2	3	4	5	6	7	8	9	10	11	12	13	14	15
T	A	T	A	#	T	A	A	A	#	T	A	T	A	#	\$
SA	15	14	4	9	13	3	8	7	6	11	1	12	2	5	10
DA	0	3	1	2	3	1	2	2	2	3	1	3	1	2	3

Definition: Document Array

Given a document concatenation \mathcal{C} and its suffix array SA , the **document array** DA is defined as

$$DA[i] = j \iff \sum_{k=1}^{j-1} |d_k| < SA[i] \leq \sum_{k=1}^j |d_k|$$

for $i > 1$ and $DA[1] = 0$

Suffix Array for Document Concatenation

- given a document concatenation \mathcal{C} , build the suffix array
- requires $O(n)$ time
- entries in suffix array correspond to documents

	1	2	3	4	5	6	7	8	9	10	11	12	13	14	15
T	A	T	A	#	T	A	A	A	#	T	A	T	A	#	\$
SA	15	14	4	9	13	3	8	7	6	11	1	12	2	5	10
DA	0	3	1	2	3	1	2	2	2	3	1	3	1	2	3

Definition: Document Array

Given a document concatenation \mathcal{C} and its suffix array SA , the **document array** DA is defined as

$$DA[i] = j \iff \sum_{k=1}^{j-1} |d_k| < SA[i] \leq \sum_{k=1}^j |d_k|$$

for $i > 1$ and $DA[1] = 0$

-  **PINGO** are the document and suffix array sufficient to return all documents?

Naive Document Listing

- given document concatenation \mathcal{C} , its suffix array SA , and document array DA
- enhance suffix array to do pattern matching in $O(|P|)$ time ⓘ only briefly discussed in lecture
- find interval in suffix array matching P
- report all documents in interval in DA
- problem: $O(|P| + N)$ query time ⓘ very bad

	1	2	3	4	5	6	7	8	9	10	11	12	13	14	15
T	A	T	A	#	T	A	A	A	#	T	A	T	A	#	\$
SA	15	14	4	9	13	3	8	7	6	11	1	12	2	5	10
DA	0	3	1	2	3	1	2	2	2	3	1	3	1	2	3

Naive Document Listing

- given document concatenation \mathcal{C} , its suffix array SA , and document array DA
- enhance suffix array to do pattern matching in $O(|P|)$ time ⓘ only briefly discussed in lecture
- find interval in suffix array matching P
- report all documents in interval in DA
- problem: $O(|P| + N)$ query time ⓘ very bad

	1	2	3	4	5	6	7	8	9	10	11	12	13	14	15
T	A	T	A	#	T	A	A	A	#	T	A	T	A	#	\$
SA	15	14	4	9	13	3	8	7	6	11	1	12	2	5	10
DA	0	3	1	2	3	1	2	2	2	3	1	3	1	2	3

- $P = TA$

Naive Document Listing

- given document concatenation \mathcal{C} , its suffix array SA , and document array DA
- enhance suffix array to do pattern matching in $O(|P|)$ time ⓘ only briefly discussed in lecture
- find interval in suffix array matching P
- report all documents in interval in DA
- problem: $O(|P| + N)$ query time ⓘ very bad

	1	2	3	4	5	6	7	8	9	10	11	12	13	14	15
T	A	T	A	#	T	A	A	A	#	T	A	T	A	#	\$
SA	15	14	4	9	13	3	8	7	6	11	1	12	2	5	10
DA	0	3	1	2	3	1	2	2	2	3	1	3	1	2	3

- $P = TA$

Naive Document Listing

- given document concatenation \mathcal{C} , its suffix array SA , and document array DA
- enhance suffix array to do pattern matching in $O(|P|)$ time ⓘ only briefly discussed in lecture
- find interval in suffix array matching P
- report all documents in interval in DA
- problem: $O(|P| + N)$ query time ⓘ very bad

- is there a better solution?
- better query time
- better (or at least equal) space requirements?

	1	2	3	4	5	6	7	8	9	10	11	12	13	14	15
T	A	T	A	#	T	A	A	A	#	T	A	T	A	#	\$
SA	15	14	4	9	13	3	8	7	6	11	1	12	2	5	10
DA	0	3	1	2	3	1	2	2	2	3	1	3	1	2	3

- $P = TA$

Optimal Time Document Listing (1/2) [Mut02]

Definition: Chain Array

Given document concatenation \mathcal{C} , its suffix array SA , and document array DA , the **chain array** CA is defined as

$$CA[i] = \max\{j < i : DA[j] = DA[i]\} \cup \{0\}$$

- chains same documents together
- find lexicographically smaller suffix of same document
- use it to report documents just once
- build RMQ data structure for CA

	1	2	3	4	5	6	7	8	9	10	11	12	13	14	15
T	A	T	A	#	T	A	A	A	#	T	A	T	A	#	\$
SA	15	14	4	9	13	3	8	7	6	11	1	12	2	5	10
DA	0	3	1	2	3	1	2	2	2	3	1	3	1	2	3
CA	0	0	0	0	2	3	4	7	8	5	6	10	11	9	12

Optimal Time Document Listing (1/2) [Mut02]

Definition: Chain Array

Given document concatenation \mathcal{C} , its suffix array SA , and document array DA , the **chain array** CA is defined as

$$CA[i] = \max\{j < i : DA[j] = DA[i]\} \cup \{0\}$$

- chains same documents together
- find lexicographically smaller suffix of same document
- use it to report documents just once
- build RMQ data structure for CA

	1	2	3	4	5	6	7	8	9	10	11	12	13	14	15
T	A	T	A	#	T	A	A	A	#	T	A	T	A	#	\$
SA	15	14	4	9	13	3	8	7	6	11	1	12	2	5	10
DA	0	3	1	2	3	1	2	2	2	3	1	3	1	2	3
CA	0	0	0	0	2	3	4	7	8	5	6	10	11	9	12

- $P = TA$

Optimal Time Document Listing (1/2) [Mut02]

Definition: Chain Array

Given document concatenation \mathcal{C} , its suffix array SA , and document array DA , the **chain array** CA is defined as

$$CA[i] = \max\{j < i : DA[j] = DA[i]\} \cup \{0\}$$

- chains same documents together
- find lexicographically smaller suffix of same document
- use it to report documents just once
- build RMQ data structure for CA

	1	2	3	4	5	6	7	8	9	10	11	12	13	14	15
T	A	T	A	#	T	A	A	A	#	T	A	T	A	#	\$
SA	15	14	4	9	13	3	8	7	6	11	1	12	2	5	10
DA	0	3	1	2	3	1	2	2	2	3	1	3	1	2	3
CA	0	0	0	0	2	3	4	7	8	5	6	10	11	9	12

- $P = TA$

Optimal Time Document Listing (1/2) [Mut02]

Definition: Chain Array

Given document concatenation \mathcal{C} , its suffix array SA , and document array DA , the **chain array** CA is defined as

$$CA[i] = \max\{j < i : DA[j] = DA[i]\} \cup \{0\}$$

- chains same documents together
- find lexicographically smaller suffix of same document
- use it to report documents just once
- build RMQ data structure for CA

	1	2	3	4	5	6	7	8	9	10	11	12	13	14	15
T	A	T	A	#	T	A	A	A	#	T	A	T	A	#	\$
SA	15	14	4	9	13	3	8	7	6	11	1	12	2	5	10
DA	0	3	1	2	3	1	2	2	2	3	1	3	1	2	3
CA	0	0	0	0	2	3	4	7	8	5	6	10	11	9	12

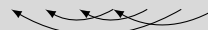

- $P = TA$

Optimal Time Document Listing (1/2) [Mut02]

Definition: Chain Array

Given document concatenation \mathcal{C} , its suffix array SA , and document array DA , the **chain array** CA is defined as

$$CA[i] = \max\{j < i : DA[j] = DA[i]\} \cup \{0\}$$

- chains same documents together
- find lexicographically smaller suffix of same document
- use it to report documents just once
- build RMQ data structure for CA

	1	2	3	4	5	6	7	8	9	10	11	12	13	14	15
T	A	T	A	#	T	A	A	A	#	T	A	T	A	#	\$
SA	15	14	4	9	13	3	8	7	6	11	1	12	2	5	10
DA	0	3	1	2	3	1	2	2	2	3	1	3	1	2	3
CA	0	0	0	0	2	3	4	7	8	5	6	10	11	9	12

- $P = TA$

Optimal Time Document Listing (1/2) [Mut02]

Definition: Chain Array

Given document concatenation \mathcal{C} , its suffix array SA , and document array DA , the **chain array** CA is defined as

$$CA[i] = \max\{j < i : DA[j] = DA[i]\} \cup \{0\}$$

- chains same documents together
- find lexicographically smaller suffix of same document
- use it to report documents just once
- build RMQ data structure for CA

	1	2	3	4	5	6	7	8	9	10	11	12	13	14	15
T	A	T	A	#	T	A	A	A	#	T	A	T	A	#	\$
SA	15	14	4	9	13	3	8	7	6	11	1	12	2	5	10
DA	0	3	1	2	3	1	2	2	2	3	1	3	1	2	3
CA	0	0	0	0	2	3	4	7	8	5	6	10	11	9	12

- $P = TA$

-  **PINGO** is the chain array with RMQs enough to list all documents in optimal time?

Optimal Time Document Listing (2/2)

- given document concatenation \mathcal{C} , its suffix array SA , document array DA , and chain array CA with RMQ data structure
- find interval $SA[s, e]$ as before
- report document $DA[m]$ only if $CA[m] < s$ for $m \in [s, e]$

	1	2	3	4	5	6	7	8	9	10	11	12	13	14	15
T	A	T	A	#	T	A	A	A	#	T	A	T	A	#	\$
SA	15	14	4	9	13	3	8	7	6	11	1	12	2	5	10
DA	0	3	1	2	3	1	2	2	2	3	1	3	1	2	3
CA	0	0	0	0	2	3	4	7	8	5	6	10	11	9	12

- $P = TA$

Optimal Time Document Listing (2/2)

- given document concatenation \mathcal{C} , its suffix array SA , document array DA , and chain array CA with RMQ data structure
- find interval $SA[s, e]$ as before
- report document $DA[m]$ only if $CA[m] < s$ for $m \in [s, e]$

- find all positions where $CA[m] < s$ with RMQs
- get arg min of CA in interval and report $DA[m]$ if $CA[m] < s$
- split interval in $[s, m - 1]$ and $[m + 1, e]$ and recurse
- ignore intervals where nothing is reported

	1	2	3	4	5	6	7	8	9	10	11	12	13	14	15
T	A	T	A	#	T	A	A	A	#	T	A	T	A	#	\$
SA	15	14	4	9	13	3	8	7	6	11	1	12	2	5	10
DA	0	3	1	2	3	1	2	2	2	3	1	3	1	2	3
CA	0	0	0	0	2	3	4	7	8	5	6	10	11	9	12

- $P = TA$

Optimal Time Document Listing (2/2)

- given document concatenation \mathcal{C} , its suffix array SA , document array DA , and chain array CA with RMQ data structure
- find interval $SA[s, e]$ as before
- report document $DA[m]$ only if $CA[m] < s$ for $m \in [s, e]$

- find all positions where $CA[m] < s$ with RMQs
- get arg min of CA in interval and report $DA[m]$ if $CA[m] < s$
- split interval in $[s, m - 1]$ and $[m + 1, e]$ and recurse
- ignore intervals where nothing is reported

	1	2	3	4	5	6	7	8	9	10	11	12	13	14	15
T	A	T	A	#	T	A	A	A	#	T	A	T	A	#	\$
SA	15	14	4	9	13	3	8	7	6	11	1	12	2	5	10
DA	0	3	1	2	3	1	2	2	2	3	1	3	1	2	3
CA	0	0	0	0	2	3	4	7	8	5	6	10	11	9	12

- $P = TA$

Lemma: Optimal Document Listing

Listing all documents containing a pattern P can be done in $O(|P| + occ)$ time

Top- k Document Retrieval for Single-Term Frequencies

Definition: Top- k Document Retrieval

Given a collection of D documents $\mathcal{D} = \{d_1, d_2, \dots, d_D\}$ containing symbols from an alphabet $\Sigma = [1, \sigma]$, a pattern $P \in \Sigma^*$, and a **threshold** k , return the top- k documents $j \in [1, D]$, such that d_j contains P most often

- retrieve occ distinct documents where P occurs
- determine frequency of P in each document
- maintain min-heap of (frequency,document)-pairs of size k
- total time: $O(|P| + occ(\lg k + \lg N))$

Top- k Document Retrieval for Single-Term Frequencies

Definition: Top- k Document Retrieval

Given a collection of D documents $\mathcal{D} = \{d_1, d_2, \dots, d_D\}$ containing symbols from an alphabet $\Sigma = [1, \sigma]$, a pattern $P \in \Sigma^*$, and a **threshold** k , return the top- k documents $j \in [1, D]$, such that d_j contains P most often

- retrieve occ distinct documents where P occurs
- determine frequency of P in each document
- maintain min-heap of (frequency,document)-pairs of size k
- total time: $O(|P| + occ(\lg k + \lg N))$

- occ can be N
- can we do better

Top- k Document Retrieval for Single-Term Frequencies

Definition: Top- k Document Retrieval

Given a collection of D documents $\mathcal{D} = \{d_1, d_2, \dots, d_D\}$ containing symbols from an alphabet $\Sigma = [1, \sigma]$, a pattern $P \in \Sigma^*$, and a **threshold** k , return the top- k documents $j \in [1, D]$, such that d_j contains P most often

- retrieve occ distinct documents where P occurs
- determine frequency of P in each document
- maintain min-heap of (frequency,document)-pairs of size k
- total time: $O(|P| + occ(\lg k + \lg N))$

- occ can be N
- can we do better

- optimal solution: $O(|P| + k)$ query time in $O(N \lg N)$ bits [NN12]
- now: $O(|P| + k \lg N)$ [GKN17]

Recap: Suffix Tree

Definition: Suffix Tree [Wei73]

A suffix tree (*ST*) for a text *T* of length *n* is a

- compact trie
- over $S = \{T[1..n], T[2..n], \dots, T[n..n]\}$
 - ⓘ suffixes are prefix-free due to sentinel

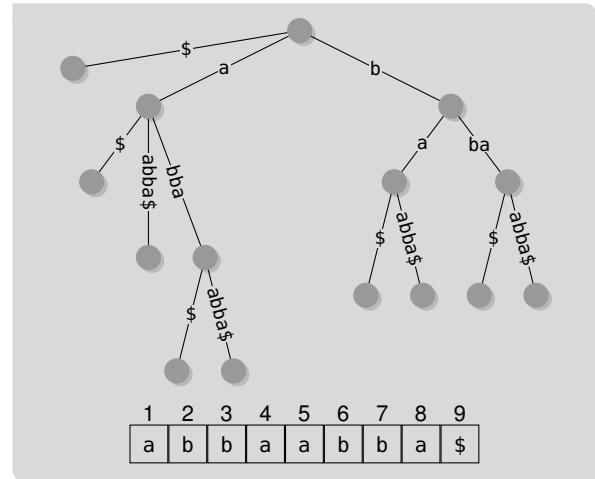

Recap: Suffix Tree

Definition: Suffix Tree [Wei73]

A suffix tree (ST) for a text T of length n is a

- compact trie
- over $S = \{T[1..n], T[2..n], \dots, T[n..n]\}$
 - ⓘ suffixes are prefix-free due to sentinel

Let $G = (V, E)$ be a compact trie with root r and a node $v \in V$, then

- $\lambda(v)$ is the concatenation of labels from r to v
- $d(v) = |\lambda(v)|$ is the string-depth of v
 - ⓘ string depth \neq depth

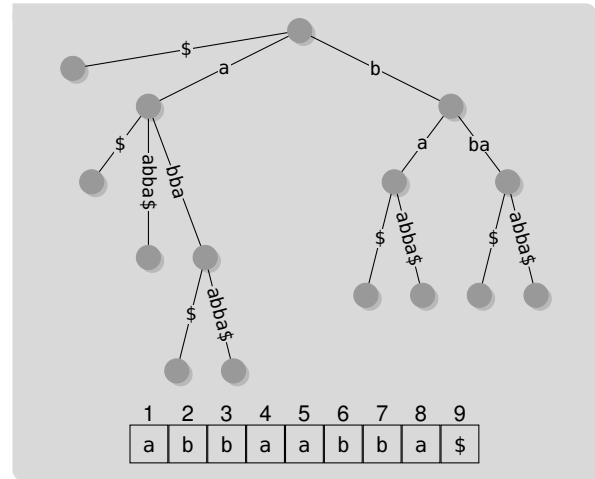

Recap: Suffix Tree

Definition: Suffix Tree [Wei73]

A suffix tree (ST) for a text T of length n is a

- compact trie
- over $S = \{T[1..n], T[2..n], \dots, T[n..n]\}$
 - ⓘ suffixes are prefix-free due to sentinel

Let $G = (V, E)$ be a compact trie with root r and a node $v \in V$, then

- $\lambda(v)$ is the concatenation of labels from r to v
- $d(v) = |\lambda(v)|$ is the string-depth of v
 - ⓘ string depth \neq depth

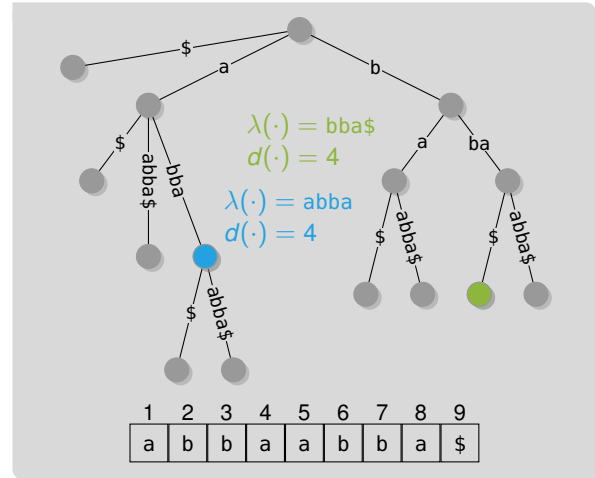

Generalized Suffix Tree for Top- k Document Retrieval (1/4)

- a **generalized** suffix tree is a suffix tree for a set of strings
- document concatenation is a set of strings

Mark Document Numbers

- mark all leaves with *DA-entry* i

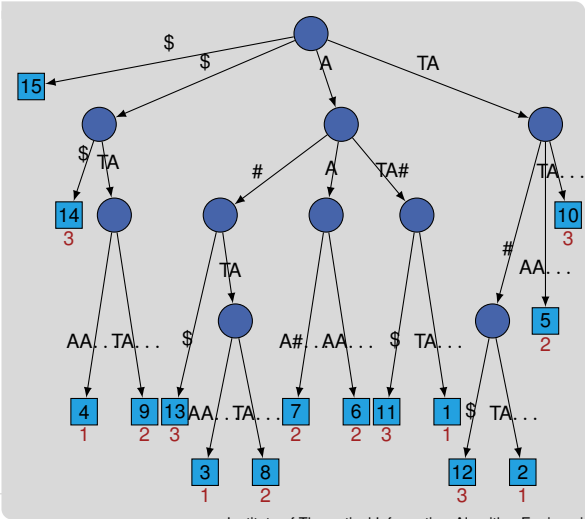

Generalized Suffix Tree for Top- k Document Retrieval (1/4)

- a **generalized** suffix tree is a suffix tree for a set of strings
- document concatenation is a set of strings

Mark Document Numbers

- mark all leaves with DA -entry i
- add i to nodes that are lowest common ancestor of two leaves marked with i

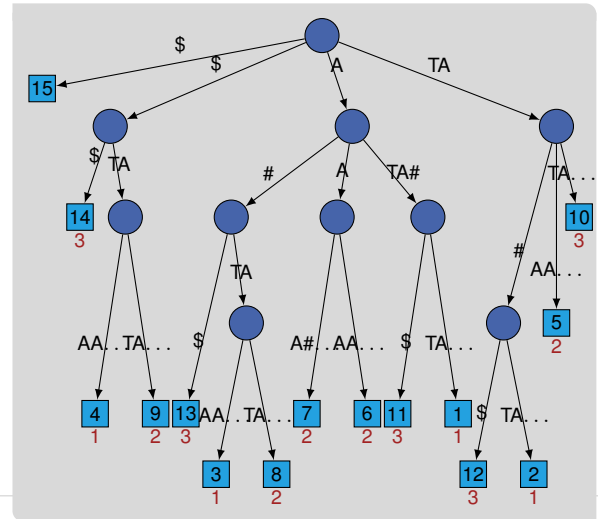

Generalized Suffix Tree for Top- k Document Retrieval (1/4)

- a **generalized** suffix tree is a suffix tree for a set of strings
- document concatenation is a set of strings

Mark Document Numbers

- mark all leaves with DA -entry i
- add i to nodes that are lowest common ancestor of two leaves marked with i

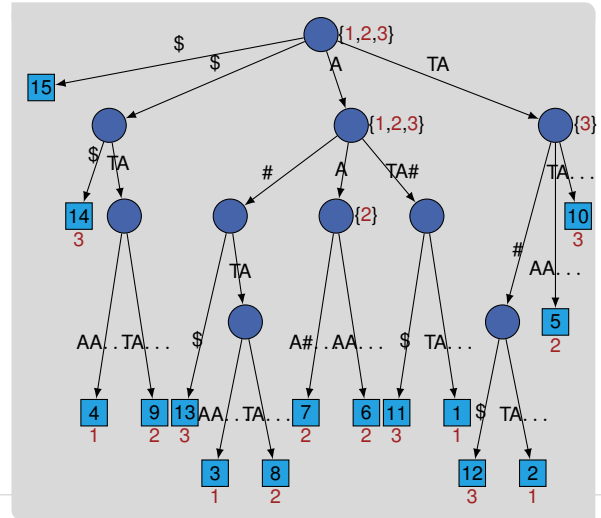

Generalized Suffix Tree for Top- k Document Retrieval (2/4)

Inner Node Names

- leaf index is rank of suffix in $[1, M]$ in leaf
- each inner node gets v gets $id(v)$, which is the leaf index of rightmost leaf in leftmost child

- $id(v) \neq id(w)$ for all inner nodes $v \neq w$
- $id(v) \in [1, M]$
- $id(v) - 1 \in [lb(v), rb(v)]$, with $[lb(v), rb(v)]$ being v 's suffix array interval

- example on the board 

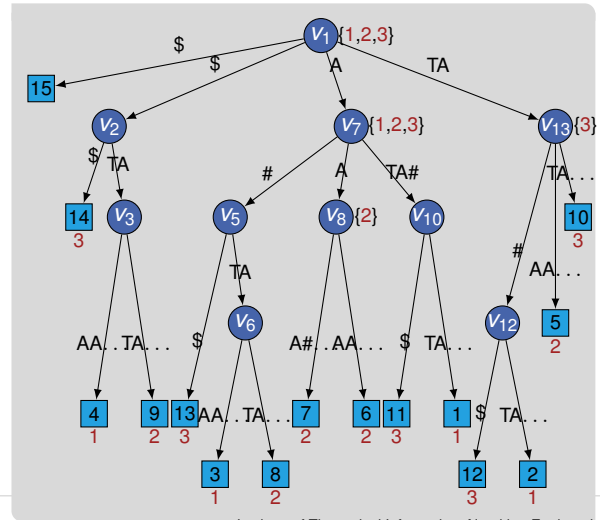

Generalized Suffix Tree for Top- k Document Retrieval (3/4)

- connect node with id i to closest ancestor containing id i
- nodes marked with id i correspond to suffix tree of d_i
- document id i occurs at most $|d_i|$ times in leaves and $|d_i| - 1$ times in inner nodes
- there are at most $O(N)$ document ids in the generalized suffix tree

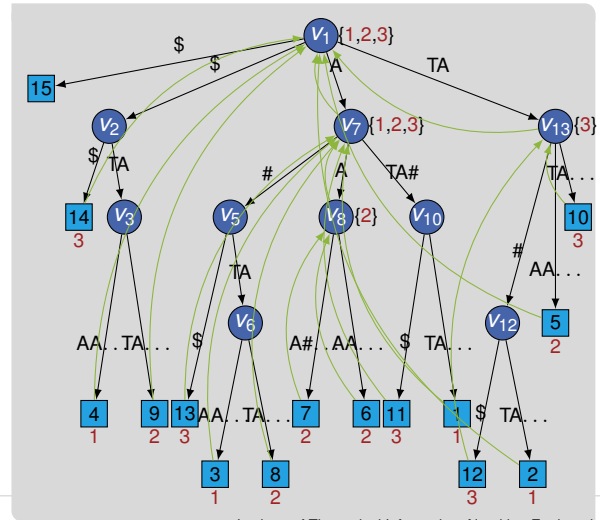



Generalized Suffix Tree for Top- k Document Retrieval (4/4)

- to retrieve documents containing pattern P
- select **locus** of P \textcircled{i} first node v with P is prefix of $\lambda(v)$

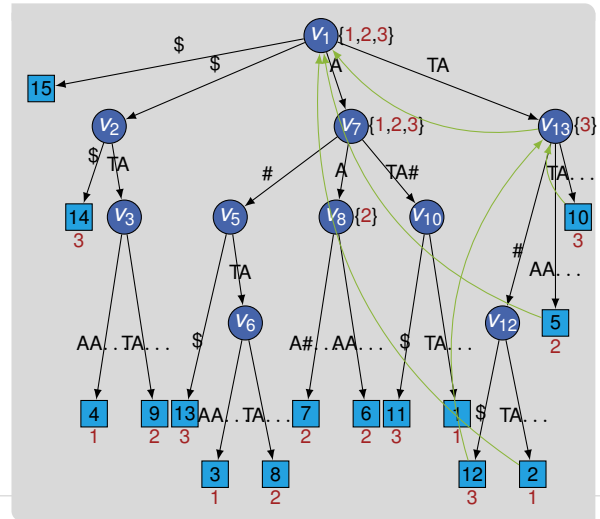
- per document at most one pointer leaves subtree of locus v
- associate each pointer with number of occurrences of documents in pointers source (weight)
- pointer of document i leaving subtree has maximum weight of all document i pointers in subtree
- document listing is listing all documents of pointers leaving subtree



Representing Pointers on a Grid (1/2)

- now: report top- k documents
- represent pointers in a grid 
- for simplicity only weights ≥ 2  starting at inner node

- assign each pointer to (x, y) -coordinate
 - x : $id(\text{source})$
 - y : $d(\text{target})$
- each point is associated with pointers weight

- given a locus v , all pointers leaving the subtree have y -coordinate $< d(v)$

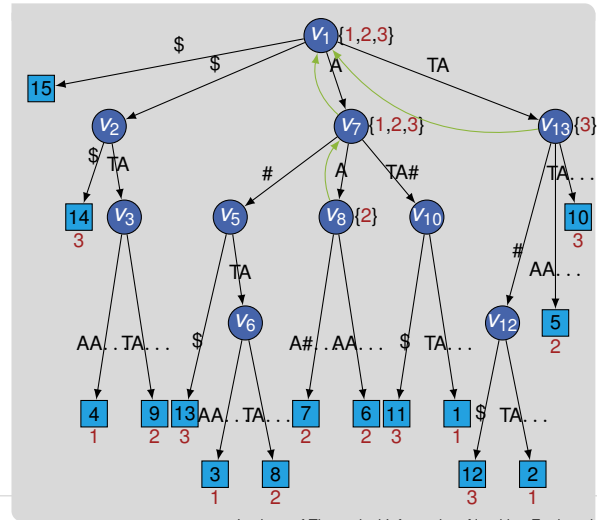

Representing Pointers on a Grid (2/2)

- grid can be represented using wavelet tree
- range **maximum** query for each level

Answering Queries

- find string depth of locus in suffix tree
- answer range query in grid
- if represented as wavelet tree, use RMQs on each level to report top- k documents
- if $\leq k$ documents, use document listing
- total time: $O(m + k \lg N)$

Representing Pointers on a Grid (2/2)

- grid can be represented using wavelet tree
- range **maximum** query for each level

-  **PINGO** how can we represent the pointers in a grid?

Answering Queries

- find string depth of locus in suffix tree
- answer range query in grid
- if represented as wavelet tree, use RMQs on each level to report top- k documents
- if $\leq k$ documents, use document listing
- total time: $O(m + k \lg N)$

Representing Pointers on a Grid (2/2)

- grid can be represented using wavelet tree
- range **maximum** query for each level

Answering Queries

- find string depth of locus in suffix tree
- answer range query in grid
- if represented as wavelet tree, use RMQs on each level to report top- k documents
- if $\leq k$ documents, use document listing
- total time: $O(m + k \lg N)$

-  **PINGO** how can we represent the pointers in a grid?

- example range queries in wavelet trees on the board 

Conclusion and Outlook

This Lecture

- document listing
- top- k document retrieval (single term frequency)

Linear Time Construction

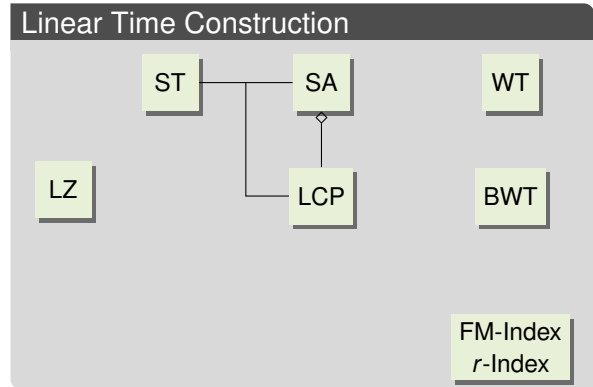

Bibliography I

- [GKN17] Simon Gog, Roberto Konow, and Gonzalo Navarro. “Practical Compact Indexes for Top- k Document Retrieval”. In: *ACM J. Exp. Algorithmics* 22 (2017). DOI: [10.1145/3043958](https://doi.org/10.1145/3043958).
- [Mut02] S. Muthukrishnan. “Efficient Algorithms for Document Retrieval Problems”. In: *SODA. ACM/SIAM*, 2002, pages 657–666.
- [NN12] Gonzalo Navarro and Yakov Nekrich. “Top- k document retrieval in optimal time and linear space”. In: *SODA. SIAM*, 2012, pages 1066–1077. DOI: [10.1137/1.9781611973099.84](https://doi.org/10.1137/1.9781611973099.84).
- [Wei73] Peter Weiner. “Linear Pattern Matching Algorithms”. In: *SWAT (FOCS)*. IEEE Computer Society, 1973, pages 1–11. DOI: [10.1109/SWAT.1973.13](https://doi.org/10.1109/SWAT.1973.13).